



HDIAAC

Homeland Defense & Security
Information Analysis Center



**Methods for Investigating
Chemical/Biological
Weapons Use**

State of the Art Report

DISTRIBUTION A. APPROVED FOR PUBLIC RELEASE: DISTRIBUTION UNLIMITED

**STATE OF THE ART REPORT:
Methods for Investigating Chemical/Biological Weapons Use**

Jamie Glover, HDIAC
Joel Hewett, HDIAC
R. Cory Bernhards, DTRA
Phillip Mach, RDECOM C&B Center
Bryan Rivers, RDECOM C&B Center
Mark Widder, USACEHR
Theresa Curtis, State University of New York at Cortland
Lisa Cazares, USAMRIID
Linda Brennan, USACEHR
John Lewis, USACEHR
David Trader, USACEHR
Courtney Morrell, USAMRIID
Ernst Brueggeman, USAMRIID
Tara Kenny, USAMRIID
Michael Ward, USAMRIID
William Dennis, USACEHR
Satori M. Thomas, Hood College
Nicolette Henning, University of Maryland
William van der Schalie, Oak Ridge Institute for Science and Education
Valerie DiVito, USACEHR
Trisha Miller, Sandia National Laboratories
Sean DeRosa, Sandia National Laboratories

2018

Contract Number: FA8075-13-D-0001

Sponsorship Statement:

HDIAC is a DoD sponsored Information Analysis Center (IAC) with policy oversight provided by the Under Secretary of Defense for Research and Engineering (USD (R&E)), and administratively managed by the Defense Technical Information Center (DTIC). HDIAC is operated by Information International Associates (IIa) in Oak Ridge, Tenn. Reference herein to any specific commercial products, processes or services by trade name, trademark, manufacturer or otherwise, does not necessarily constitute or imply its endorsement, recommendation or favoring by the United States government or HDIAC. The views and opinions of authors expressed herein do not necessarily state or reflect those of the United States government or HDIAC and shall not be used for advertising or product endorsement purposes.

About This Publication:

Copyright 2018 by IIa. This State of the Art Report was developed by IIa under HDIAC contract FA8075-13-D-0001. The government has unlimited free use of and access to this publication and its contents in both print and electronic versions. Subject to the rights of the government, this document (print and electronic versions) and the contents contained within it are protected by U.S. copyright law and may not be copied, automated, resold or redistributed to multiple users without the written permission of HDIAC.

Distribution A:

Approved for Public Release; Distribution Unlimited

This page intentionally left blank.

Contents

AUTHORS	4
ACRONYMS	9
EXECUTIVE SUMMARY	11
1 INTRODUCTION	12
2 DETECTION TECHNOLOGIES FOR CHEMICAL AND BIOLOGICAL AGENTS	15
3 BIOLOGICALLY-BASED TOXICITY SENSORS FOR DETECTION OF CHEMICALS IN DRINKING WATER	35
4 INVENTORY AND SUPPLY CHAIN MANAGEMENT TECHNOLOGIES FOR SITUATIONAL AWARENESS	70
5 FORENSIC CONSIDERATIONS IN THE INVESTIGATION OF BIOLOGICAL WEAPONS USE	89
6 AFTERWORD	102

Authors

Jamie Glover, MPH, M.S.

Homeland Defense & Security Information Analysis Center (HDIAC)

Jamie Glover is the research lead at the HDIAC. Before joining HDIAC in 2017, Glover spent nearly a decade in public health research and practice within government, academia, and industry. She holds a Master of Public Health and a Master of Science in Nutrition from the University of Tennessee, as well as a Bachelor of Science in Human Environmental Sciences from the University of Arkansas.

Joel Hewett, M.S.

Homeland Defense & Security Information Analysis Center (HDIAC)

Joel Hewett is a subject matter expert with HDIAC, where he applies a decade of experience in energy technology issues. He holds an M.S. from the Georgia Institute of Technology in the history and sociology of technology and science, where he was the inaugural Melvin Kranzberg fellow. Hewett also holds an A.B. in literature from Davidson College, where he was a John Montgomery Belk scholar. His book-length study of the offshore oil and gas program in the United States, *The Secret of the Sea*, will be published by the Department of the Interior in 2018.

R. Cory Bernhards, Ph.D.

Defense Threat Reduction Agency (DTRA)

R. Cory Bernhards is a research microbiologist at DTRA, conducting research at U.S. Army Research, Development, and Engineering Command Chemical & Biological (RDECOM C&B) Center at Aberdeen Proving Ground, MD (B.S. and Ph.D., biological sciences, Virginia Polytechnic Institute and State University). His research focuses on novel detection systems for bioterror agents, including rapid sample preparation and field-deployable devices. Previously, Bernhards conducted an NRC Postdoctoral Fellowship at the U.S. Army Medical Research Institute of Infectious Diseases in Frederick, MD, where he performed research on *Burkholderia* and *Bacillus anthracis*.

Phillip M. Mach, Ph.D.

U.S. Army Research, Development, and Engineering Command Chemical & Biological Center (RDECOM C&B)

Phillip M. Mach received his Ph.D. from the University of North Texas developing highly sensitive portable vapor mass spectrometers. He has deployed prototype systems in the Antarctic harsh environment and has been featured on the Discovery Channel. Mach has written more than 15 peer-reviewed articles, a book chapter on environmental forensics, and has been awarded three patents. His research interests include charge transfer dissociation and top-down proteomics.

Bryan Rivers, M.S.

U.S. Army Research, Development, and Engineering Command Chemical & Biological Center (RDECOM C&B)

Bryan Rivers joined the RDECOM C&B Center in 2010 (M.S., biology, University of North Carolina at Charlotte; B.S., biology, University of North Carolina at Chapel Hill). His notable projects include developing molecular tools to understand the mutation rate and mechanism of adaptive mutations in *Yersinia pestis*; producing biothreat simulants with chromosomal tags for tracking; managing bio-identification hardware evaluations (BioSensors Testbed); and early assay development and evaluation of hand-held devices. Rivers is experienced in transitioning laboratory workflows to field and mobile environments as well as developing training programs for new technologies.

Mark Widder, M.S.

U.S. Army Center for Environmental Health Research (USACEHR)

Mark Widder is a research biologist at USACEHR in the Environmental Health Program located at Fort Detrick in Frederick, MD (M.S., environmental science, Hood College). He has worked for the U.S. Army for more than 20 years in the applied medical research areas of toxicology and biosensor development to support soldier health and preventive medicine.

Theresa Curtis, Ph.D.

State University of New York at Cortland

Theresa Curtis is a professor of biological sciences at the State University of New York at Cortland (Ph.D., physiology and cell biology, Albany Medical College). She is interested in the development of cell-based biosensors to detect environmental threats.

Lisa Cazares, Ph.D.

U.S. Army Medical Research Institute of Infectious Diseases (USAMRIID)

Lisa Cazares is the lead scientist and Director of the Proteomics/Metabolomics Mass Spectrometry facility at USAMRIID, where her research interests include the development of mass spectrometry techniques for metabolite profiling, host-pathogen protein interaction studies, and the discovery of biomarkers of infection. Cazares has 20 years of experience in mass spectrometry and has authored more than 50 peer-reviewed publications in microbiology, prostate cancer protein profiling, metabolic tissue imaging, and clinical proteomics.

Linda Brennan, M.S.

U.S. Army Center for Environmental Health Research (USACEHR)

Linda Brennan is a research biologist at USACEHR (M.S., environmental biology, Hood College). Her research efforts have focused on assisting in the development and in-house testing of the U.S. Army's Environmental Sentinel Biomonitor

System, which is comprised of water toxicity sensors designed to be used by soldiers to detect chemical toxicants in drinking water.

John Lewis, Ph.D.

U.S. Army Center for Environmental Health Research (USACEHR)

John Lewis is deputy director of the USACEHR Environmental Health Program and lead for the program's microbiome initiative. He has worked at USACEHR since 2002 and held a variety of roles there, including research biologist, assistant program director, deputy program director, and executive officer. His early research focused on toxicological studies in alternate species using proteomic and genomic techniques. His current research focuses on the use of a systems toxicology approach to elucidate mechanisms of toxicity to protect soldiers from environmental toxicants. Lewis became a Diplomate of the American Board of Toxicology in 2014.

David Trader, M.S.

U.S. Army Center for Environmental Health Research (USACEHR)

David Trader is a research biologist, institutional animal care and use committee chair, and executive officer at USACEHR (M.S., environmental biology, Hood College). His research interests are in water toxicity, and specifically in sensors and kits designed to detect toxic industrial chemicals.

Courtney Morrell

U.S. Army Medical Research Institute of Infectious Diseases (USAMRIID)

Courtney Morrell is a specialist in the U.S. Army, currently working at the U.S. Army Medical Research Institute of Infectious Diseases as a medical laboratory technician. SPC Morrell is proficient in the preparation and processing of proteomic and metabolomics samples for downstream mass spectrometry analysis.

Ernst Brueggeman

U.S. Army Medical Research Institute of Infectious Diseases (USAMRIID)

Ernst Brueggemann is a biological science technician at the USAMRIID. Before entering the U.S. Army as a biological science assistant, he received his B.A. in biology from Drury University. He has been active in mass spectrometry of biological molecules for more than 25 years at Fort Detrick in Frederick, MD.

Tara Kenny, M.S.

U.S. Army Medical Research Institute of Infectious Diseases (USAMRIID)

Tara Kenny manages the proteomics laboratory at USAMRIID (M.S., biomedical science, Hood College). She is an expert in cell culture, protein chemistry, molecular biology techniques, and proteomic sample processing. Kenny has supported USAMRIID research efforts since 2002.

Michael Ward

U.S. Army Medical Research Institute of Infectious Diseases (USAMRIID)

Michael Ward is a staff scientist in the laboratory of Dr. Lisa Cazares in USAMRIID's Molecular and Translational Sciences Division, and has 25 years of experience in protein biochemistry and mass spectrometry (B.S., biology, Rutgers University). Ward is one of the lead researchers for proteomic studies at USAMRIID, involved in the development of mass spectrometry approaches for therapeutic monitoring and discovery of biomarkers of infection. He is also responsible for all proteomic data analysis as well as analytical software development for in-house research projects at USAMRIID.

William Dennis

U.S. Army Center for Environmental Health Research (USACEHR)

William Dennis is an analytical chemist at USACEHR (B.A., chemistry, University of Maryland, Baltimore County). He has been performing analytical chemistry for over 25 years in support of research with a focus on mass spectroscopy.

Satori M. Thomas

Hood College

Satori M. Thomas completed her undergraduate degree (B.A., biology, Hood College) and participated as an intern in the writing of the methods section of Chapter 3 in this SOAR. Her specific focus was on molecular biology, with an interest in human anatomy and physiology. Thomas is applying to graduate school and seeking summer employment at laboratories.

Nicolette Henning

University of Maryland

Nicolette Henning completed her undergraduate degree (B.S., environmental science and technology) at the University of Maryland, College Park. Following graduation she will be involved in the development of research equipment.

William van der Schalie, Ph.D.

Oak Ridge Institute for Science and Education

William van der Schalie has an Oak Ridge Institute for Science Education Research Participation Program appointment at USACEHR (Ph.D., Virginia Polytechnic Institute and State University). He is interested in the application of toxicity sensors for chemical detection and has assisted with the research and development process for the U.S. Army's Environmental Sentinel Biomonitor System.

Valerie DiVito, Ph.D.

U.S. Army Center for Environmental Health Research (USACEHR)

Valerie DiVito leads a multidisciplinary biomedical research program at USACEHR to investigate the mechanisms of action for acute and chronic health effects caused by exposure to environmental hazards and toxicants. This work uses a systems toxicology approach to inform the development of surveillance tools, diagnostics, and interventions to prevent and/or mitigate the adverse consequences from toxicant exposure, including decreased military performance in occupational and operational environments.

Trisha Miller, Ph.D.

Sandia National Laboratories

Trisha Miller is a principal member of the technical staff in a Systems Research and Analysis group at Sandia National Laboratories (Ph.D., chemistry, University of California at Berkeley; B.S., chemistry, Creighton University). Miller has led numerous chemical security analysis projects in support of the Department of Homeland Security and the Defense Threat Reduction Agency. She has also supported several other security analysis projects spanning the chemical/biological/radiological/nuclear hazard space.

Sean DeRosa, Ph.D.

Sandia National Laboratories

Sean DeRosa is a senior member of the technical staff at Sandia National Laboratories where he works on the risk management of critical infrastructure (Ph.D. and M.S., chemical engineering, University of Texas at Austin; B.S., chemical engineering, University of Arizona). DeRosa has supported the Departments of Energy and Homeland Security with expertise in chemical and energy infrastructure. He also leads impact assessments of developments in chemical manufacturing, including emerging manufacturing opportunities from natural gas liquids and their impact on global chemical trade.

Acronyms

1st AML	1st Area Medical Laboratory
ACHE	Acetylcholinesterase
AFMESA	Air Force Medical Evaluation Support Activity
AMEDD	U.S. Army Medical Department
ASSURED.....	Affordable, Sensitive, Specific, User-friendly, Rapid and Robust, Equipment-free, and Deliverable to End-users
BIS	Bureau of Industry and Security
CBDP	Chemical and Biological Defense Program
CBRN.....	Chemical/Biological/Radiological/Nuclear
CDD.....	Capability Development Document
CE	Carboxyl Esterase
CFATS	Chemical Facility Anti-Terrorism Standards
CONUS	Continental U.S.
CWA.....	Chemical Warfare Agent
CWC	Chemical Weapons Convention
DART	Direct Analysis in Real Time
DoD.....	Department of Defense
DHS	Department of Homeland Security
DOE	Department of Energy
DTRA	Defense Threat Reduction Agency
ECIS.....	Electric Cell-substrate Impedance Sensing
ELISAs	Enzyme-linked Immunosorbent Assays
EPA.....	Environmental Protection Agency
ePADs.....	Electrochemical Paper-based Analytical Devices
ESB	Environmental Sentinel Biomonitor
ESI	Electrospray Ionization
FDA.....	Food and Drug Administration
DIY	Do-It-Yourself
GAO.....	U.S. Government Accountability Office
GC-MS	Gas Chromatography Mass Spectrometer
HDIAC.....	Homeland Defense & Information Analysis Center
HLC.....	Human Lethal Concentration
IR	Infrared
LAMP	Loop-mediated Isothermal Amplification
LC	Liquid Chromatography
LFI.....	Lateral Flow Immunoassays
MALDI	Matrix-assisted Laser Desorption/Ionization
MEG	Military Exposure Guideline
MOPP	Mission-oriented Protective Posture
MSD.....	Meso Scale Discovery
NCTR	National Center for Toxicological Research
NMR	Nuclear Magnetic Resonance
OPCW	Organisation for the Prohibition of Chemical Weapons
PACS	Physical Access Control Systems
PCR	Polymerase Chain Reaction
POC	Point-of-Care
PPE	Personal Protective Equipment
RDECOM C&B Center	U.S. Army Research, Development, and Engineering Command Chemical & Biological Center

RDT&E	Research, Development, Testing, and Evaluation
SOAR	State of the Art Report
SPME	Solid-phase Microextraction
SPR	Surface Plasmon Resonance
SWAP	Size, Weight, and Power
TIC	Toxic Industrial Chemicals
TTEP	Technology Testing and Evaluation Program
USACEHR	U.S. Army Center for Environmental Health Research
USAMRIID	U.S. Army Medical Research Institute of Infectious Diseases
UV	Ultraviolet
WMD	Weapons of Mass Destruction
WQAS-PM	Water Quality Analysis Set – Preventive Medicine

Executive Summary

The Homeland Defense & Security Information Analysis Center (HDIAC) develops State of the Art Reports (SOARs) on scientific and technical topics that are relevant to the Department of Defense (DoD). This SOAR focuses on technologies and methods regarding the investigation of alleged chemical and/or biological weapons use as it pertains to DoD's mission to protect U.S. forces and the homeland from chemical and biological weapons of mass destruction (WMD).

Strategically and operationally, countering these weapons to ensure that the United States and our allies and partners are never attacked nor threatened by them remains a top priority for DoD. If an adversary or rogue nation uses chemical or biological weapons, it is critical to ensure that DoD and civilian leaders are provided with accurate, reliable, specific, and timely information in the wake of an attack.

This data may include information regarding an agent's type, origin, concentration (or lethality), and other salient technical characteristics necessary to inform: (a) a potential determination of source, (b) the target and scope of a military quick reaction force counter-assault activity, and/or (c) what protective measures should be taken by personnel under threat of further attack.

This report focuses on two major aspects of chemical and biological weapons use: (a) the state of the art in advanced sensor technology (the fundamental core of the defense mission at hand) and (b) organizational best practices and tools for ensuring accurate and comprehensive situational awareness of chemical and biological weapons, precursor materials and substances, and the related resources required to develop and weaponize chemical and biological agents. This SOAR highlights recent, cutting-edge research in this field that will be essential for warfighter protection and sustainment in the next five to 10 years.

1

Introduction

Joel Hewett, HDIAC

While the use of chemical and biological weapons against civilians and combatants has been prohibited by international convention in at least some form since the Geneva Protocol of 1925 came into force [1], select rogue states and non-state actors remain highly motivated to acquire—and deploy—both classes of WMD [2]. Strategically and operationally countering these weapons to ensure that the United States and her allies and partners are never attacked nor threatened by them remains a top priority for DoD [3].

Ensuring our military commanders, DoD leaders, and Department of Homeland Security (DHS) and U.S. diplomatic officials receive accurate, reliable, specific, and timely information in the wake of a chemical or biological agent attack remains equally important. This data may include information regarding an agent's type, origin, concentration (or lethality), and other technical characteristics necessary to inform: (a) a potential determination of source, (b) the target and scope of a military quick reaction force counter-assault activity, and/or (c) the protective measures to be taken by personnel under threat of further attack.

DoD and federal government responsibilities further call for the identification and characterization of deployed chemical and biological weapons agents, when possible, in order to inform both acute and long-term medical care of exposed individuals. The wide array of medical countermeasures stockpiled and issued by DoD relies on timely agent identification to be effective [4].

The Chemical and Biological Defense Program (CBDP), reporting to the Assistant Secretary of Defense for Nuclear, Chemical, and Biological Defense Programs, is DoD's centralized organization for enabling the warfighter to “deter, prevent, mitigate, respond, and recover from CBRN [chemical/biological/radiological/nuclear] threats and their effects [5].” One of CBDP's three core defense priorities is to “develop detection and diagnostic systems for [chemical and biological] agents that can be used in the field and in garrison,” while ensuring that adequate “processes are in place for the effective sharing of critical information [5].”

CBDP has recently funded multiple research, development, testing, and evaluation (RDT&E) projects focused on advancing novel ways of detecting the use of a chemical or biological weapon [6]. Representative efforts include the development of the Mano Sampling Device, or MANO, a plastic and sponge-based warfighter-protection tool that allows a field investigator to acquire a biological sample quickly and with a higher degree of safety than previously allowed.

The detection and identification space, including sampling equipment and technologies, is exceptionally broad. Furthermore, RDT&E in the chemical and biological detection and identification technology arena occurs across disparate military, government, academic, and private research organizations. These capabilities encompass high-tech sensors, optical and spectroscopic scanners,

nanoparticle microfluidic arrays, isothermal amplification techniques, and mass spectrometers—as well as “low-tech” sampling tools like MANO.

This report focuses on two major aspects of chemical and biological weapons use: (a) the state of the art in advanced sensor technology—the fundamental core of the defense mission at hand—and (b) organizational best practices and tools for ensuring accurate and comprehensive situational awareness of weapons agents, precursor materials and substances, and the related resources required to protect against the development and weaponization chemical and biological agents.

In their chapter of this report, “Detection Technologies for Chemical and Biological Agents,” R. Cory Bernhards, Phillip Mach, and Bryan Rivers (from the U.S. Army Research, Development, and Engineering Command Chemical & Biological Center, and the Defense Threat Reduction Agency) provide a survey of detection and sensor technologies for chemical and biological weapons use. They also detail how advances in seemingly unrelated technical fields—from microfluidics to computational power—have combined to reduce the size and weight typically required to house a given field-deployable detection tool. Miniaturization, however, is no technical panacea for deploying these devices. As the authors write, “the further downrange the technology can be deployed, the faster an agent can be identified.” However, they also note that the downsizing of such equipment “presents unique challenges to sensitivity and specificity.”

In the next chapter, a research team comprised of individuals from the U.S. Army Center for Environmental Health Research, the State University of New York at Cortland, the U.S. Army Medical Research Institute of Infectious Diseases, Hood College, the University of Maryland at College Park, and the Oak Ridge Institute for Science and Education discusses “Biologically-based Toxicity Sensors for Detection of Chemicals in Drinking Water.” Widder et al. assess the limitations in current technologies capable of detecting the presence of toxic chemicals in potable water, a critical capability for force protection. The authors then discuss innovations in a biological cell-based sensor system, the Environmental Sentinel Biomonitor, which can perform a test in less than an hour. Widder et al. also survey other cell lines that have been used elsewhere in the underlying electric cell-substrate impedance sensing procedure.

Next, Trisha Miller and Sean DeRosa of Sandia National Laboratories explore “Inventory and Supply Chain Management Technologies for Situational Awareness.” As they explain, chemical detection and biological characterization sensor technologies represent only one side of the chemical and biological weapon investigation coin. Contextual or indirect data, including node-level tracking information of weapon constituents, are a “key component of investigations into WMD use.” Situational awareness on a broader, systemic level, as Miller and DeRosa explain, can “enable pre-incident interdiction and post-incident attribution.”

Finally, HDIAC Research Lead Jamie Glover discusses “Forensic Considerations in the Investigation of Biological Weapons Use,” providing an examination of emerging biological threats and the technologies and strategies soon to be deployed for homeland defense.

References

1. League of Nations (1925, June). 1925 Geneva Protocol, Protocol for the prohibition of the use in war of asphyxiating, poisonous or other gases, and of bacteriological methods of warfare. Retrieved from <https://www.un.org/disarmament/wmd/bio/1925-geneva-protocol/>
2. Nuclear Threat Initiative (2018, April). Countries: North Korea: Chemical. Retrieved from <http://www.nti.org/learn/countries/north-korea/chemical/>
3. U.S. Department of Defense (2014, June). Department of Defense strategy for countering weapons of mass destruction. Retrieved from https://www.defense.gov/Portals/1/Documents/pubs/DoD_Strategy_for_Countering_Weapons_of_Mass_Destruction_dated_June_2014.pdf
4. Joellenbeck, L. M., Durch, J., & Benet, L. Z. (Eds.). (2004). *Giving full measure to countermeasures: Addressing problems in the DOD program to develop medical countermeasures against biological warfare agents*. Washington, D.C.: National Academies Press. Retrieved from <https://www.ncbi.nlm.nih.gov/books/NBK215958/>
5. Fizer, R. (2017, February 2). *Chemical and Biological Defense Program (CBDP) Overview*. Speech presented at the Advanced Planning Briefing for Industry at Aberdeen Proving Ground, MD. Retrieved from <https://osbp.apg.army.mil/PDF/APBI/2017/Day%204.02%20-%20CBDP%20Overview.pdf>
6. U.S. Army Edgewood Chemical Biological Center, Research & Technology Directorate. (2017, Fall). R&T Scientists Enable Future Army Forces with New Technology. *The R&T Connection*, 4, 8. Retrieved from https://www.ecbc.army.mil/wp-content/uploads/2018/04/RTconnection_Issue4_web.pdf

2

Detection Technologies for Chemical and Biological Agents

*R. Cory Bernhards, DTRA
Phillip M. Mach, RDECOM C&B Center
Bryan Rivers, RDECOM C&B Center*

Introduction

Advances in computational power, communication capabilities, and microfluidics have accelerated the development of new chemical and biological threat agent detection and identification technologies, some of which are becoming available to the warfighter. Many of the emerging diagnostic devices, chemical analyzers, and biosensors are designed to be used at or near the point of sample origination, such as the bedside for medical devices or a sampling site for first responders. The further downrange the technology can be deployed, the faster an agent can be identified. These technologies must be highly accurate for field-confirmatory analysis, and downsizing presents unique challenges to sensitivity and specificity. This chapter discusses advanced field-deployable chemical detection technologies including chromatographic, colorimetric, and spectroscopic methods, as well as fieldable biological detection methods spanning lateral flow immunoassays, polymerase chain reaction, isothermal amplification, paper-based assays, and nanopore sequencing. This chapter also discusses the outlook for future fieldable chemical and biological detection devices for the warfighter.

Recent Advancements

The ever-increasing processing power of computers and the ever-decreasing size of microchips continually improve the design of fieldable chemical and biological detection devices. Advancements in communication have also aided the design of these devices, as the ubiquity and improving functionality of cell phones have allowed for their integration with detection devices. For instance, cell phone applications have been designed to excite and measure fluorescence during DNA amplification [1]. These devices can also upload results to the internet for chemical and biological monitoring. For military defense purposes, devices are being designed to communicate results directly to subject matter experts and decision makers. This is not a trivial task when taking into account data security and requirements for DoD networks.

In the past few decades, there has been a surge in the development of microfluidic devices for biological detection technologies, especially for point-of-care (POC) diagnostics. These devices are commonly manufactured using soft lithography techniques with polydimethylsiloxane [2]. Alternatively, they can be made using laser cutting or plotter cutting (xurography). Advancements in 3D printing technologies also facilitated the design and production of a variety of microfluidic devices.

Chemical Detection/Identification

Small-molecule identification has been a cornerstone target of spectroscopic and spectrometric techniques for decades. Most fielded analytical systems rely heavily upon built libraries of known chemistries, which makes identification wholly based upon the previously generated knowledge base. Current methods of identification of emerging threats depend on an *a priori* regime, whereby structure may be: (a) a moiety change to a parent compound or (b) an unknown chemistry that may not have been previously encountered. True identification of chemical threats requires confirmatory analysis and tandem approaches to reduce false positives. Practitioners use a suite of laboratory techniques including nuclear magnetic resonance (NMR), spectroscopy (ultraviolet, visible, and infrared), and mass spectrometric analysis to fully characterize a given unknown. Fielded technologies rely on broad fingerprinting of chemistry to minimally identify a threat as a given class of compounds, or utilize approaches to specifically identify with a high degree of confidence by applying previous knowledge bases and tandem approaches. Chemical sensing methods are experiencing a resurgence with a breadth of new and innovative techniques on the horizon. This section aims to provide a brief overview of advanced chemical identification instrumentation, with specific focus on fielded or near-fielded technologies within DoD.

Matrix Complexity and Sample Preparation

To ensure effective sample preparation for warfighters using portable chemical detectors in the field, methods of sample preparation need to be minimal yet compatible with the analysis method. Unfortunately, no universal sample preparation method exists for any analytical technique; however, general paradigms are often followed. Preferentially, a sample preparation technique should minimize environmental contamination and reduce dilution effects or sample losses, while preventing future chemical alteration to the sample (e.g., hydrolysis). Within the forensic community, it is commonplace to sample not only the unknown, but also a matrix-matched sample without the contaminant. For example, with soils, a contaminated sample would be retained, but care should be taken to also collect a soil sample known to be uncontaminated. With more sensitive instrumentation the practice of micro-sample preparation has become more commonplace [3]. These techniques, while reducing the quantity of analyte, reduce the amount of overall prepared sample with the goal of reducing the quantity of interfering environmental matrix. Analytically, environmental matrices universally contribute to ion suppression and ion interferences in mass spectrometry while producing confounding spectra in spectroscopic techniques and reduced operability with colorimetric assays [4]. Overall, techniques seek to reduce the amount of interfering background by sampling a similar matrix to determine the contribution of interference, dilute the background matrix out, and sample only areas with known targets present.

Mass Spectrometry

Over nearly three decades of development [5], the portable mass analyzer has fulfilled roles within the armed forces, international regulatory agencies, and commercial uses to provide onsite chemical identification. One of the earliest releases of a portable instrument, still widely used, is the Inficon Hapsite ER gas chromatography mass spectrometer (GC-MS). This briefcase-like system possesses a range of sampling abilities, including compatibility with solid-phase

extractive techniques, and it introduced the sampling wand as a viable option for point source sample collection. While the system has undergone modern upgrades, the form factor and two-button operation has remained unchanged, and it has an extensive library index. Most recently, newly published datasets regarding chemical warfare agents (CWAs) have elucidated limits-of-detection for a wide range of non-V-series agents [6]. Remarkably, in the referenced study, fuels were used as an interfering compound—indicating that some loss of signal occurs with specific chemistries. Complementing this research, V-series agents were fluorinated using an online derivatization method in the sample stream [7]. Native VX and VR were not detected; however, the fluorination process allowed for detection of the expected indicative compound with yields suitable for field identification.

Equally as established, and currently fielded to military operators, the Smiths Detection GUARDION GC-MS platform operates with similar size, albeit with a fetch-and-retrieve sampling modality. This platform relies on solid-phase microextraction (SPME) fibers, which operate like a click-pen. Primarily, sample is collected on the SPME device via direct contact or wafting near the sample vapors. Using GC-MS techniques, hardware and operational developments streamlined the analysis with contact closures and simple interfaces. The GUARDION platform has been tested against a variety of toxic industrial chemicals (TICs) and CWAs [8], and provided physiologically relevant results.

The final platform in the class of fieldable tandem GC-MS systems is the FLIR G510, a next-generation product to the G400 series. This system is designed to incorporate handheld, wand-based sampling for the surveying of possible threats, while including the traditional GC-MS based direct-sample injection. As a newly developed product, there is no peer-reviewed published literature for reference at the time of writing [9]. However, this system will offer numerous similarities to laboratory-grade instrumentation, including splitless and split-flows for highly concentrated samples, larger vacuum pumping capacities, and library-based indices for identification with throughputs of approximately 10 per hour.

These systems collectively have years of operational use, or are based upon tried-and-true systems, with proven capabilities for identification of organics, TICs, and CWAs. However, further development is needed, especially regarding local law enforcement forensic settings for the identification of opioids. Opioids are low volatility compounds with chemical intricacies that, while analytically capable, require new methods of analyses on these enumerated platforms.

Portable chemical identifiers have also begun to incorporate ambient ionization techniques [10]. With innovative improvements in ion optics, machining, and vacuum systems, platforms that use ambient ionization are becoming more mainstream. The overall recent improvements can be surmised by the innovations to generate a molecular species that will reach the chemical detector, while traversing from ambient pressure to high vacuum. While a variety of ambient ionization techniques exist, highlighted here are those that have been proven to be incorporated effectively into their given platform.

Direct analysis in real time (DART) is an ionization technique that is compatible with solids, liquids, and gasses [11]. This method was traditionally paired with large

time-of-flight mass analyzers that relegated it to laboratory workspaces only. Recently, Lonsense and Waters have jointly developed a DART system based upon the qDa instrument platform. This reduced-size quadrupole mass analyzer is capable of ambient ionization, thus amenable to the DART technique. DART briefly subjects a sample to a stream of heated inert gases that ionize liberated samples from a collection device for mass analysis. This prepress technique conquers analysis in complex matrices, including environmental samples, such as opioids and pesticides [12]. This system, although in its infancy, is ripe for further hardware refinement and method development and has been subject to research efforts to build applicable libraries to the DART ionization technique.

Laboratory-grade instrumentation typically relies on the near universal electrospray ionization (ESI) method for sample introduction. Few portable platforms exist that have been continually developed utilizing this technique. ESI, fundamentally, is a method of generating a spray that forms gaseous ionized molecules. This phenomenon occurs regardless of the size of the analyte molecule, making the technique amenable to small chemistries and large biomolecules.

The new Continuity platform from Bayspec benefited from DoD Small Business Technology Transfer guidance [13]. This platform includes novel ion generation and innovative optics paired with proven mass analyzers—a robust system with a wide range of detection possibilities. Continuity is a renewed platform subject to further development, for a wide range of ion generation sources. These systems now perform experiments similar to those once relegated to laboratory environments in the field, such as tandem mass analysis. Implementing new technologies, such as the Continuity platform, enhances warfighter capabilities to improve identification of chemical threats.

Optical Spectroscopy and Colorimetric Arrays

Spectroscopic techniques observe various wavelengths of light in relation to chemical structure. Specifically, functional groups and moieties have signature wavelengths that are detectable with various toolkits. Techniques such as Raman and infrared (IR) have been used in forensic settings for chemical sensing [14]. Unique to these techniques is the ability to observe through containment, such as translucent plastic bags, affording an opportunity to identify with less contamination risk to the warfighter. Furthermore, these techniques can be applied to latent evidence, such as fingerprints, attributing a human identifier with chemistry contained within imprinted ridges.

Statistical analysis, including extrapolation of confounding spectrums, has resulted in Raman- and IR-based detection of CWAs, but more intriguing is determining the route of manufacture [15]. Attributing a synthesis route uses the impurities or markers left behind in the sample from the method of creation. Spectroscopy is further capable of imaging approaches whereby deterministic spectra are associated in a 2D space over a given area. Most recently, Raman- and IR-based techniques have advanced fingerprinting research [16], localizing specific chemistries to regions on imaged fingerprints. Moreover, practitioners must be wary of confounding chemistries, as spectroscopic results are not wholly deterministic of a specific compound but are classified based on structure and moieties; therefore, class-based detection is prevalent. Colorimetric arrays offer a

static modality to determine the presence of a chemical of interest in an assay-type platform [17]. Automation of the readout of this device has resulted in kits, whereby observations are made spectrally and results are streamlined [18].

Fieldability

Deployment feasibility of a system has broad requirements, with specific figures of merit targeted for mission downselect. Broadly, systems employed by the warfighter should be capable of molecular and organic analysis, with confirmed capabilities of the intended situation. For this section, focus has been concentrated on commercial off-the-shelf technologies, weight limited to man-portable, allowing for 10+ samples per battery, while requiring minimal supporting infrastructure for operation. Size, weight, and power (SWaP) refers to the encompassing governance regarding these figures of merit, which ultimately determines the feasibility of deployment. At the time of writing, there are a handful of proven, deployed systems and new prototype technologies on the horizon. Most systems are designed to perform well in one subset of vapor, liquid, or solid sampling—but not with universal detection capability. By combining each type of source, analyzer, and detector, a unique analytical toolkit can be created.

Emerging Technologies/Future Outlook

There are new and emerging techniques that conquer many of the shortcomings presented herein. In the mass analysis arena, there are novel scan types being developed for portable systems that were traditionally reserved for laboratory-grade instruments. Neutral loss scan is a type of tandem mass analysis specific for observing chargeless moiety losses. This type of scan is hardware-limited from portable mass analyzers, and recent developments have seen this procedure operated in a linear ion trap mass analyzer [19]. The neutral loss regime, amongst other scan types, will soon allow for in-the-field “omics,” including lipidomics and metabolomics. Sampling techniques moved toward being preless, concentrating on single-use sample introduction cartridges, which remove matrices from samples. Paper spray ionization is an advanced ambient ionization technique that is becoming more user friendly [20–22]. Paper spray has been proven useful for biofluids, environmental soil and water, and ambient air, and is nearing further advancement as a universal sampling and analysis platform. We expect to see high-resolution detectors for chemical platforms fielded in the next 10 years. The revelation of the Orbitrap mass analyzer was a substantial leap forward for laboratory instrumentation [23]. Further miniaturization of vacuum hardware will aid in the creation of compact chemical sensing devices, with the ultimate goal of creating a device similar to the “tricorder” of science fiction.

Biological Detection/Identification

Environmental Detection

Matrix Complexity and Sample Preparation

Environmental sampling encompasses obtaining biological samples from a wide range of matrices, including water (e.g., drinking water, wastewater), plants/vegetation, vectors (mosquitoes), aerosols (air), culture media, suspicious powders, and soil. Like chemical analyses, there is no universal sample preparation method. While some laboratories (such as those testing the potability of a water source) can concentrate on one matrix type, other laboratories and

incident response teams must prepare for challenges associated with simultaneously testing multiple matrices. For example, a European Commission study noted in 2006 that although CBRN responders should be prepared to obtain solids, air, soil, liquids, vegetation, whole animals and insects, nasal swabs, body fluids, and tissue, it is rare that all sample types would need to be collected from a single incident [24]. However, collecting a biological sample from a solid surface (a suspicious white powder, for example) can be complicated, and there is no “one-size-fits-all” solution. Factors that must be considered include the location, size, and composition of the surface [25]. In other words, scientists must be cognizant of the collection efficiency for the method they employ.

Using a sampling method yielding the highest collection efficiency is not the only concern when trying to obtain identification of an unknown biological sample. Researchers must also design and evaluate methods to remove the biological sample from the excipient matrix components due to the number of interfering and inhibiting compounds present in environmental matrices. These compounds include particulates, humic acid, organic and inorganic compounds, lipids, sugar, alcohols, and divalent ions. For immunoassays, the issue is most often discussed under the umbrella term matrix effects. The pH and ionic strength of the sample buffer can also have a major effect due to charge modification of the analyte. For enzyme-linked immunosorbent assays (ELISAs), even the brand and composition of the polystyrene plate can significantly affect the sensitivity and specificity of the assay. Interfering substances (such as proteins in the sample with similar epitopes as the analyte) can also cause spurious results due to nonspecific binding to assay components, thus blocking binding sites for the analyte. Molecular assays, such as PCR, are also affected by the matrix compounds. However, molecular assays are typically performed on extracted samples—that is, samples that have been purified and enriched using methods that specifically bind the nucleic acid, allowing the matrix to be washed away. The bound nucleic acids are then eluted from the capture matrix and used for the assay. The amount of material remaining after these extraction steps is often referred to as extraction efficiency. Collection efficiency and extraction efficiency often result in a reduction of the amount of analyte present, profoundly affecting the overall effective limit of detection for any identification method, whether immunological- or molecular-based.

Soil is regarded as an especially problematic matrix for biological detection, in part due to the presence of various amplification inhibitors. For instance, humic acid is present in the organic matter content of soil, and is a known DNA amplification inhibitor. Neutralizers can be used in DNA preparation methods to mitigate the effects of humic acid and other amplification inhibitors. Another complex challenge regarding soil matrices is that large particles can clog collection and extraction devices.

Immunological Detection (Antibody-based)

For the purpose of this section, we will describe immunological assays as lateral flow devices, plate-based assays, microbead-based assays, and biosensors. Lateral flow immunoassays (LFIs, sometimes referred to as LFAs) are simple devices on which a sample is applied to an absorbent pad that then diffuses laterally across the device, binding to detection and labeling molecules along the way. When the sample front crosses the detection pad, a colored band forms if the labeling molecule has also bound to the sample. A control line forms when excess

labeling molecules reach a second detection area specific to the label, indicating all reagents have properly traversed the strip. Home pregnancy tests are one of the most common types of LFI used worldwide [26]; however, the assay has wide applicability to environmental and biodefense detection in addition to its established role as a diagnostic tool. For example, warfighters on sensitive site exploitation missions use LFIs to initially test samples, such as suspicious white powders. There are multiple suppliers of LFIs for biothreats available for first responders and DoD assets such as the National Guard Civil Support Teams, but those fielded to military units are supplied by the DoD's Defense Biological Product Assurance Office.

Using LFI technology in the field offers several advantages to the warfighter, including ease of device preparation, stability over a wide range of environmental conditions, long shelf life, user-friendly operation with little training, quick analysis time, easy integration with electronics, and little to no energy consumption [27]. Many LFIs can be stored at room temperature, and shelf life can be extended by storing in a refrigerator. Ease of use is especially important to military operators because they often use arrays of LFIs while encumbered by mission-oriented protective posture (MOPP) gear. Disadvantages of LFI technology include overall lower sensitivity relative to other immunoassay technologies and small dynamic range complicated by the "Hook Effect," a reduction in signal when the concentration of analyte is high. To increase sensitivity, researchers are pursuing alternatives to the colloidal gold labels currently used. Upconverting phosphors are just one of the options being studied and have shown sensitivity increases of 100- to 1,000-fold [28]. LFIs that detect more than one analyte, so-called multiplex LFIs, have been developed by placing detector pads in series on the nitrocellulose paper backing or labeling the detection antibodies with quantum dots [29]. However, identification based on any single type of LFI should be considered presumptive due to high false-positive and false-negative rates, and the results should be confirmed with more sensitive immunoassays or molecular-based assays.

ELISAs were developed in the early 1970s as an alternative to radiolabeled detection methods [30]. These assays are performed in multiwell plates and result in the formation of a colored byproduct or photons that can be measured. The use of multiwell plates allows the simultaneous analysis of many samples and the quick testing of multiple reaction conditions to optimize the assay. Additionally, the format of the plate-based assay often affords the ability to include controls to offset matrix effects [31]. ELISAs are commonly used to measure pesticides, industrial chemicals, and toxins in air, water, food, and soil [31]. Often, the amount of colored by-product or light that is generated by the enzyme-labeled detector in the assay is tightly correlated with the amount of analyte, thereby allowing quantitation of the analyte. Because ELISAs are based on the measurement of a colorimetric byproduct or light, they are generally singleplex assays, but assay developers have overcome this limitation by changing to 2D array spots on surfaces or by using microbead-based assays [32]. The complex tasks required to perform many immunoassays preclude their use in field situations, but these tasks can be performed in a mobile or fixed laboratory. The Common Analytical Laboratory System Field Confirmatory Analytical Capability Set (CALS-FC-ACS) is undergoing testing and contains the PR2-1800, which uses multiplex plate-based MULTI-ARRAY and MULTI-SPOT immunoassay technology developed by Meso Scale Discovery (MSD) [33]. Their MULTI-SPOT plates incorporate multiple

antibody coated spots in an array within each well of the plate, making each spot specific to one analyte. MSD reports the plates incorporate up to 10 individual spots and offer a dynamic detection range of more than five logs.

Assay developers have transitioned to microbead-based immunoassays in an effort to increase the multiplexity of the detection assay. Like the plastic surface of ELISA and MULTI-SPOT plates, the solid surface of the microbeads is modified to bind to specific biomolecules, and the binding capacity of the beads is much higher due to the increased surface area [34]. The immunochemical binding reactions that occur on the bead surface can be performed in either tubes or plates (depending upon the number of samples requiring analysis), and detection of the reaction can be performed by chemiluminescence or fluorescence measurements in a flow cell. Assays using microbead technology have been used in the detection of a variety of analytes in multiple matrices, including fungal spores in indoor air [35], marine toxins in water [36], bacterial toxins in food [37], and enteric virus in sewage [38]. It should be noted that microbead-based technology can also be used for molecular detection (nucleic acid-based) because oligonucleotides can also be coupled to the microbeads. This enhances the flexibility of these platforms. In 2013, Luminex Corporation was awarded an \$11.6 million contract by DTRA to miniaturize their microbead-based technology into a portable system capable of detecting DNA, RNA, and protein [39].

Immunoassays are most often developed with a reporter molecule—be it an enzyme or fluorophore—that is attached to (labeled to) the detector antibody. The labeled reporter molecule is used to increase the amount of signal in the assay relative to background levels, thus increasing the sensitivity of the assay. Other assays, called label-free immunoassays, do not rely on a labeled component. These assays contain a bioactive element, such as a capture antibody on the sensor surface. Binding of the analyte to the bioactive element produces a change that can be mechanically, electronically, or optically measured. When an analyte binds to the bioactive element on a sensor, the weight of the sensor changes slightly. This small change can be detected with a cantilever biosensor, a subtype of mechanical biosensors. Surface plasmon resonance (SPR) is an example of a change that can be optically measured.

In SPR, a light source is focused on the sensor surface and the light has a characteristic angle of reflection. When the amount of material on the sensor surface changes, the angle of reflection changes slightly, and some of the light energy is converted into a plasmon wave that propagates along the surface of the sensor. Researchers from the Institute of Agrifood Research and Technology (Spain) and the University of South Australia reviewed electrochemical biosensors that detect toxins. They summarized 82 different sensors that detect analytes ranging from ochratoxin A to anthrax protective antigen, finding that 82 percent of the sensors contained either a polyclonal or monoclonal antibody as its bioreactive element [40]. Researchers from the University Complutense of Madrid reviewed biosensors relevant to monitoring food safety, noting myriad available electrochemical biosensors [41]. The development of label-free biosensors has continued as new materials such as graphene, carbon nanotubes, and other nanomaterials are incorporated into their design. These innovations are pushing the limits of detection to previously unimagined domains [42].

Molecular Detection (Nucleic Acid-based)

Molecular detection refers to DNA/RNA-based detection. Polymerase chain reaction (PCR), first described by Kary Mullis, Ph.D. in the 1980s, is a way to select a piece of DNA in a sample and amplify the amount of it. The process involves the cyclic unfolding of the double-stranded DNA structure, application of short oligonucleotide sequences (primers) specific to the DNA of interest, and enzymatic duplication of the DNA sequence between the two primers. Each cycle of amplification doubles the amount of target DNA, exponentially increasing the amount of DNA. Polymerase chain reactions quickly revolutionized molecular biology. An analysis of PubMed literature citations conducted for calendar year 2000 returned more than 16,000 publications mentioning the phrase (overall, PCR was mentioned in 3 percent of all PubMed publications) [43]. PCR assays can be characterized as either end-point or real-time [44]. In end-point assays, the DNA products must be examined using a second assay. Some of the options include running a small amount of the amplicon on an agarose or polyacrylamide gel, measuring the amount of double-stranded DNA in the product pre- and post-PCR, or performing melting curve analysis of the products. Melting curve analysis involves incorporating a double-strand specific binding dye, such as SYBR Green, lowering the temperature to a level where all DNA is expected to be annealed, then slowly raising the temperature while monitoring for a change in the fluorescence of the dye. When the temperature at which the PCR product denatures is reached, the fluorescence significantly decreases [45], and each PCR product has a characteristic melting temperature dictated by the sequence of the amplicon. It should be noted that the first order derivative of the change in fluorescence is being evaluated; therefore, this assay is not quantitative.

Real-time or quantitative PCR differs from end-point because the increase in DNA concentration is monitored after each amplification cycle, most often by measuring the fluorescence of the reaction. There are many different chemistries that can be used to monitor PCR, including hydrolysis probes, major groove binders, Scorpion primer-probes, and molecular beacons [46].

Very little instrumentation is required to perform end-point PCR, especially when the products are analyzed on a gel. In fact, before the development of the thermal cycler, researchers used water baths set at three different temperatures and manually moved the tubes between baths. On the other hand, melting curve analysis and real-time monitoring of PCR require a thermal cycler, an excitation source, lenses and filters to focus and select the emission wavelength, and a photomultiplier or charged coupled device camera to capture fluorescence.

There are many PCR-based detection instruments in use today, including some that are used by the warfighter. The RAZOR EX and FilmArray from BioFire have been fielded to military operators. While the RAZOR EX was designed specifically for field use by first responders and military CBRN response elements [47], the FilmArray is limited to a laboratory environment. The FilmArray was selected as the Next Generation Diagnostics System device—replacing the currently fielded Joint Biological Agent Identification and Diagnostic System (JBAIDS)—and will be used by DoD laboratory units to analyze both environmental and diagnostic specimens [48]. Additionally, lighter PCR-based detection instruments capable of use in forward operating positions have been developed and are small enough to be easily carried by the warfighter.

Isothermal amplification technologies have an advantage over PCR in that they only require a single temperature. This increases fieldability by significantly decreasing power requirements. The most widely used isothermal amplification technique is called loop-mediated isothermal amplification (LAMP), which uses a set of six primers to amplify DNA at a constant temperature of around 65 degrees Celsius. Other types of isothermal amplification include recombinase polymerase amplification (RPA) and polymerase spiral reaction (PSR) [49]. LAMP and RPA have also been combined to increase sensitivity [50]. These technologies use different polymerases, reaction temperatures, and primers sets. There are a number of devices in development that use isothermal amplification, but none have yet been fielded to the warfighter.

Next-generation sequencing technologies offer the ability to quickly sequence genomes at relatively low cost and can offer non-biased (non-targeted) detection. Illumina sequencing technologies include the MiSeq and HiSeq instruments, which generate large amounts of short reads. Pacific Biosciences also offers sequencing instruments that generate longer reads. However, all of these instruments are not fieldable because they are large, heavy, and require stable power. More recently, nanopore sequencing technology has allowed for a dramatic reduction in instrument size. In nanopore sequencing, protein nanopores are embedded in an electrically resistant polymer membrane. When DNA molecules are passed through the nanopores, changes in current are detected, which reflect the identity of the DNA bases. The MinION device from Oxford Nanopore Technologies utilizes nanopore sequencing and is the only portable genomic sequencer. It has been used to sequence DNA in Antarctica [51] and on the International Space Station [52]. This technology is being assessed for military use in field demonstrations conducted by DoD operators. Current DoD research focuses on simplifying sample preparation and data analysis.

Alternative Technologies

There are a few biological detection technologies that are neither immunological nor molecular-based, and they include Raman spectroscopy, mass spectrometry, and paper-based assays. Raman spectroscopy has long been applied to measure chemical fingerprints based on the energy contained in the bonds of the compound. To do so, scientists excite the bonds with incident light (anything in the visible spectrum and reaching into the edges of ultraviolet and infrared) and measure the Stokes scattering. As low-noise detectors, better optics, and more precise filters have become available, scientists have begun using Raman to identify larger molecules including those in biological samples, such as whole bacteria. A variant of Raman, known as surface-enhanced Raman spectroscopy (SERS), is where a sample is absorbed onto a metal surface or mixed with self-assembling metallic nanoparticles, and the metallic components on the surface enhance the Raman signature of the biological analyte.

The size, cost, reagents, and expertise required to operate the instruments often create barriers to their use. Mass spectrometry of large proteins (including biological toxins), lipids, and metabolites can be performed following either an overall top-down or bottom-up approach. Bottom-up approaches rely on conversion of large biomolecules into smaller constituents, using enzyme-based digests. Bottom-up data processing reassembles these shorter molecular species

to identify the larger precursor molecule. Top-down analyses seek to identify intact large molecules, performing tandem mass analysis to confirm the species detected. Databases are typically used to compare and match the spectra collected to that of known biomarkers, biomolecules, and bioagents. Technologies such as liquid chromatography (LC) coupled to ESI and matrix-assisted laser desorption/ionization (MALDI) are used for ionization of the sample to provide increased separation of the analyte from excipient molecules.

Paper was evaluated early on in the development of biological assays and incorporated into lateral flow immunoassays, but it was replaced by nitrocellulose in the late 1990s [53]. In 2008, researchers from Harvard University and the University of São Paulo demonstrated that microfluidic channels could: (a) be patterned on paper using hydrophobic polymers; (b) the colorimetric reaction could be analyzed using ubiquitous cell phone cameras; and (c) the phone signal could be used to transmit the result to clinicians [54]. Microfluidic paper-based analytical devices are now called μ PADs. The paper used in μ PADs is generally cellulose-based because it is abundant, inexpensive, lightweight, and biodegradable [55]. μ PADS are typically easy to read because they are based on color changes and rely on the illumination and image capturing capabilities of cellphones. Recently, μ PADs have begun transitioning into the wearable technology space. While these devices are still in their infancy and not yet used by the warfighter, applications such as a diagnostic test for cystic fibrosis using a μ PAD incorporated into an adhesive bandage have been demonstrated [56] and offer a glimpse into future applications. Wearable sensors could be incorporated into wrist-worn devices (such as a smartwatch), incorporated into head or eye protective equipment, embedded into textiles, carried like identification tags, or affixed to (or tattooed onto) the skin [57].

In an effort to increase the sensitivity and selectivity of μ PADS, researchers from Chulalongkorn University and Colorado State University demonstrated that electrodes could be screen printed on the paper surface and technology already existing in the form of glucose self-testing meters could be used to measure ionic changes occurring during the chemical reactions [58]. The electrochemical paper-based analytical devices (ePADs) function similarly to μ PADs, but the signal is analyzed by changes at the electrode surface. Nanomaterial development is accelerating the development of ePADS. Most recently, in 2018 a research group in Brazil successfully integrated an ePAD comprised of enzyme-coated multi-walled carbon nanotubes and gold nanoparticles for the detection of phenol into textile thread [59]. While this breakthrough relies on biochemical detection, it is likely that immunological- and molecular-based detection modalities will follow as new ways to functionalize the electrode are realized.

Diagnostics

The *in vitro* diagnostics market is one of the main drivers for the development of biological assays. Like environmental assays, these tests encompass immunological, chemical, and molecular methods but are limited to matrices from the human body, including blood, plasma, urine, cerebrospinal fluid, sputum, saliva, and stool. Because of the large size of the market, oftentimes methods and devices are developed first for diagnostics then adapted to environmental samples. While working with the World Health Organization, Rosanna Peeling, Ph.D., published the ASSURED (affordable, sensitive, specific, user-friendly, rapid and

robust, equipment-free, and deliverable to end-users) selection criteria for developing and choosing a diagnostic test for sexually transmitted diseases in resource-limited environments [60]. ASSURED criteria have been adopted as a practical guide for the *in vitro* diagnostics market, specifically for the emerging POC market.

The military has a need for diagnostics at all levels of care, from Echelon I (combat lifesaver) to Echelon IV (typically found at large, continental U.S.-based military hospitals). Field medical staff require access to sophisticated POC diagnostic devices similar to equipment found in higher echelons of care in order to identify and treat patients sooner. For example, POC tools could be used to distinguish symptoms of exposure to a biological agent (like smallpox) from a common infection (influenza). In conjunction with POC tools, devices that can record physiological and cognitive status changes beginning at the time of evaluation must also be pushed to lower echelons of care.

The matrices tested using diagnostic assays are very well characterized, but because they are from human samples, there can be vast variation in any single matrix taken from a single individual even over the course of a single medical treatment. In 1998, researchers from the Estrie University Health Center in Quebec (now the Sherbrooke University Hospital Center) reviewed antibody interference relevant to thyroid disease diagnostic markers and identified three sources of interference: autoantibodies, heterophile antibodies, and rheumatoid factors [61]. The issue extends to almost any diagnostic marker evaluated by immunoassay, including steroids, cardiac enzymes, tumor markers, insulin, and viral serology; 30–40 percent of the population has interfering antibodies circulating in the bloodstream [62]. Current immunoassays are designed to remove many interfering antibodies though it is impossible to remove them all.

Assays vary depending on biological matrix and the company supplying the assay. In general, assays can be classed based on the reporter molecule used. Radioimmunoassays use a radioisotope as the indicator, whereas enzyme immunoassays use enzymes, chemiluminescent immunoassays use light generating chemistries, and fluoroimmunoassays use fluorescent molecules. ELISAs are the most often used assay in diagnostic labs and can be performed by manual and automated methods [63]. Immunoassays used for diagnostics range from single sample, POC LFIs to high throughput clinical systems capable of performing more than 200 tests per hour with approximately 75 assays [64].

Nucleic acid tests, such as PCR, have been used in diagnostic testing for the past two decades and, relative to immunoassays, display much better sensitivities and specificities. However, the performance of the assay decreases due to the presence of many inhibitory compounds unless they are removed by careful sample preparation methods. For example, many earlier PCR reactions relied on the DNA polymerase enzyme from *Thermus aquaticus* (Taq), which is inhibited by as little as 0.004 percent (v/v) blood [65]. Mayo Clinic researchers reviewed real-time PCR assays for clinical laboratory testing and noted that nucleic acid extraction was seminal to achieving accurate real-time PCR results [66]. Their review identified six companies supplying manual and automated sample extraction kits covering all clinical matrices and two products from Roche that facilitate extraction from stool and swabs. PCR assays detecting bacteria, viruses,

mycobacteria, and parasites have been developed, and the list of those approved for use in clinical laboratories is rapidly growing. Devices that couple nucleic acid extraction and PCR amplification are coming on the market and are leading the development of POC devices. The Cepheid GeneXpert system was one of the first devices that coupled extraction and PCR and did so within a sealed cartridge system. As devices move from clinical laboratory to point-of-need, an increased amount of device control must be incorporated into the device to account for user error from less highly-trained operators. In 2015, the Alere iNAT Flu A/B device and assay was the first nucleic acid amplification test to be granted Clinical Laboratory Improvement Amendments waiver status. However, much work remains before a device like the Alere iNAT could be used in a combat environment, as it must be ruggedized and adapted to function on battery power. Additionally, the Alere iNAT has a color touch screen interface that may be difficult to see in sunlight. This interface is also difficult to navigate while wearing butyl gloves.

Isothermal amplification techniques can be used for diagnostics; however, few have received Food and Drug Administration (FDA) approval. Next-generation sequencing assays have been developed for diagnostics, but they have limitations and are usually amplicon based. Efficient analysis of large amounts of sequencing data remains a challenge, especially due to the high amount of background. For fieldable sequencing, the MinION has been used to successfully monitor the Ebola virus outbreak in West Africa [67, 68] and the Zika virus outbreak in Brazil [69]. However, nanopore sequencing has not yet advanced enough to be approved for diagnostic testing.

Future Outlook

POC biological detection devices will increasingly use isothermal amplification technologies to reduce SWaP. Despite challenges associated with truly portable genomic sequencing, the technology is rapidly advancing. The open source nature of the platform from Oxford Nanopore Technologies is helping to drive this innovation. Automated sample preparation and offline data analysis are two of the biggest challenges being addressed. It is difficult to deny that portable genomic sequencing will be the biological detection technology of choice in the future. However, it is uncertain how long it will take to get there. However, targeted assays involving DNA amplification will likely remain useful to those who want to avoid sorting through biological background. Streamlined data analysis for genomic sequencing is a difficult challenge and will remain a limiting factor until it is fully optimized for the average user. This challenge is being addressed via the Empowering the Development of Genomics Expertise (EDGE) Bioinformatics tool developed at Los Alamos National Laboratory and managed by DTRA. Cost and sustainability will also continue to be major factors in the deployment of detection devices.

Conclusion

The ability to quickly and accurately detect chemical and biological threats is critically important for warfighter protection, as rapid detection helps to inform decision making. Typically, the earlier detection technology can be deployed in the field, the faster the agent can be identified. In instances where MOPP gear is required, more sophisticated detection tools can be used to potentially determine

the presence, type, and level of contamination. If a sample can be confirmed to not pose a threat, the warfighter may then be able to remove cumbersome MOPP gear, allowing for enhanced mobility and confidence. However, the detection technologies must be highly sensitive and specific for field-confirmatory analyses. Historically, weaponized threats have been based on naturally occurring pathogens. However, recent advancements in synthetic biology have made it easier than ever to genetically modify organisms, posing a new threat to the warfighter. The ability to identify unknown or genetically modified organisms will be a key focus moving forward, with portable genomic sequencing a likely solution.

Rarely do innovations that tackle these problems originate from a single corporation or research group. Instead, innovation relies on cross collaboration spanning various fields of research. For example, lighter, highly tolerant parts may be created by materials science researchers. New detectors and control circuitry may be designed by electrical engineers, and application scientists may develop innovative methods for providing chemical identification techniques for a specific need. Researchers must work together from the prototype stage to receipt by the end user to ensure the developed technology is robust enough to meet the chemical sensing needs of the warfighter.

References

1. Liao, S. C., Peng, J., Mauk, M. G., Awasthi, S., Song, J., Friedman, H., . . . Liu, C. (2016). Smart cup: A minimally-instrumented, smartphone-based point-of-care molecular diagnostic device. *Sensors and Actuators B: Chemical*, 229, 232-238. doi:10.1016/j.snb.2016.01.073
2. Whitesides, G. M., Ostuni, E., Takayama, S., Jiang, X., & Ingber, D. E. (2001). Soft lithography in biology and biochemistry. *Annual Review of Biomedical Engineering*, 3(1), 335-373. doi:10.1146/annurev.bioeng.3.1.335
3. Kabir, A., Holness, H., Furton, K. G., & Almirall, J. R. (2013). Recent advances in micro-sample preparation with forensic applications. *TrAC Trends in Analytical Chemistry*, 45, 264-279. doi:10.1016/j.trac.2012.11.013
4. Keith, L. H. (2017). *Environmental sampling and analysis: A practical guide*. New York: Routledge. (Original work published 1991)
5. Cooks, R. G., Glish, G. L., Mcluckey, S. A., & Kaiser, R. E. (1991). Ion trap mass spectrometry. *Chemical and Engineering News*, 69(12), 26-41. doi:10.1021/cen-v069n012.p026
6. Nagashima, H., Kondo, T., Nagoya, T., Ikeda, T., Kurimata, N., Unoke, S., & Seto, Y. (2015). Identification of chemical warfare agents from vapor samples using a field-portable capillary gas chromatography/membrane-interfaced electron ionization quadrupole mass spectrometry instrument with Tri-Bed concentrator. *Journal of Chromatography A*, 1406, 279-290. doi:10.1016/j.chroma.2015.06.011
7. Ohrui, Y., Nagoya, T., Kurimata, N., Sodeyama, M., & Seto, Y. (2017). Identification of V-type nerve agents in vapor samples using a field-portable capillary gas chromatography/membrane-interfaced electron ionization quadrupole mass spectrometry instrument with Tri-Bed concentrator and fluoridating conversion tube. *Journal of Mass Spectrometry*, 52(7), 472-479. doi:10.1002/jms.3951
8. Contreras, J. A., Murray, J., Tolley, S., Oliphant, J., Tolley, H., Lammert, S., . . . Lee, M. (2008). Hand-Portable Gas Chromatograph-Toroidal Ion Trap Mass Spectrometer (GC-TMS) for detection of hazardous compounds. *Journal of the American Society for Mass Spectrometry*, 19(10), 1425-1434. doi:10.1016/j.jasms.2008.06.022
9. FLIR Systems. (2018). FLIR GRIFFIN G510 [Datasheet]. Retrieved from https://www.flir.com/globalassets/imported-assets/document/17-1639-det-det-g510-datasheet_final_v2_web.pdf
10. Huang, M., Cheng, S., Cho, Y., & Shiea, J. (2011). Ambient ionization mass spectrometry: A tutorial. *Analytica Chimica Acta*. 702(1), 1-15. doi:10.1016/j.aca.2011.06.017
11. Gross, J. H. (2014). Direct analysis in real time--A critical review on DART-MS. *Analytical and Bioanalytical Chemistry*, 406(1), 63-80. doi: 10.1007/s00216-013-7316-0
12. Gómez-Ríos, G. A., Vasiljevic, T., Gionfriddo, E., Yu, M., & Pawliszyn, J. (2017). Towards on-site analysis of complex matrices by solid-phase microextraction-transmission mode coupled to a portable mass spectrometer via direct analysis in real time. *The Analyst*, 142(16), 2928-2935. doi:10.1039/c7an00718c

13. The Small Business Innovation Research Program. (2016). Miniature Mass Spectrometer for Peptide Sequencing and Mobile Coupling with Separation Techniques [Contract W911SR-16-C-0053]. Retrieved from <https://www.sbir.gov/sbirsearch/detail/1304239>
14. Ewing, A. V., & Kazarian, S. G.. (2017). Infrared spectroscopy and spectroscopic imaging in forensic science. *The Analyst*, *142*(2), 257-272. doi:10.1039/c6an02244h
15. Wiktelius, D., Ahlinder, L., Larsson, A., Holmgren, K. H., Norlin, R., & Andersson, P. O. (2018). On the use of spectra from portable Raman and ATR-IR instruments in synthesis route attribution of a chemical warfare agent by multivariate modeling. *Talanta*, *186*, 622-627. doi:10.1016/j.talanta.2018.02.108
16. Chen, T., Schultz, Z. D., & Levin, I. W. (2009). Infrared spectroscopic imaging of latent fingerprints and associated forensic evidence. *The Analyst*, *134*(9), 1902-1904. doi:10.1039/b908228j
17. Janzen, M. C., Ponder, J. B., Bailey, D. P., Ingison, C. K., & Suslick, K. S. (2006). Colorimetric sensor arrays for volatile organic compounds. *Analytical Chemistry*, *78*(11), 3591-3600. doi:10.1021/ac052111s
18. Chue, C., Miklos, A., Dixon, M., Kilper, G., Varma, R., Davidson, C., . . . Rhodes, P. (2017). *Colorimetric arrays: Enabling fast, cheap, and portable chemical identification*. Paper presented at the CBD S&T Conference, Long Beach, CA. Retrieved from <https://www.cbdstconference.com/agenda-download-abstract?AbstractId=447>
19. Snyder, D. T., & Cooks, R. G. (2017). Single analyzer neutral loss scans in a linear quadrupole ion trap using orthogonal double resonance excitation. *Analytical Chemistry*, *89*(15), 8148-8155. doi:10.1021/acs.analchem.7b01963
20. Dhummakupt, E. S., Carmany, D. O., Mach, P. M., Tovar, T. M., Ploskonka, A. M., Demond, P. S., . . . Glaros, T. (2018). Metal-Organic Framework Modified Glass Substrate for Analysis of Highly Volatile Chemical Warfare Agents by Paper Spray Mass Spectrometry. *ACS Applied Materials & Interfaces*, *10*(9), 8359-8365. doi:10.1021/acsami.7b19232
21. Dhummakupt, E. S., Mach, P. M., Carmany, D., Demond, P. S., Moran, T. S., Connell, T., . . . Glaros, T. (2017). Direct analysis of aerosolized chemical warfare simulants captured on a modified glass-based substrate by "paper-spray" ionization. *Analytical Chemistry*, *89*(20), 10866-10872. doi:10.1021/acs.analchem.7b02530
22. McKenna, J., Dhummakupt, E. S., Connell, T., Demond, P. S., Miller, D. B., Nilles, J. M., . . . Glaros, T. (2017). Detection of chemical warfare agent simulants and hydrolysis products in biological samples by paper spray mass spectrometry. *The Analyst*, *142*(9), 1442-1451. doi:10.1039/c7an00144d
23. Hu, Q., Noll, R. J., Li, H., Makarov, A., Hardman, M., & Cooks, R. G. (2005). The Orbitrap: A new mass spectrometer. *Journal of Mass Spectrometry*, *40*(4), 430-443. doi:10.1002/jms.856
24. European Commission, DG Health and Consumer Protection, Health Threat Unit. (2006). Biological incident response & environmental sampling – A European guideline on principles of field investigation. Retrieved from

- http://ec.europa.eu/health/ph_threats/com/preparedness/docs/biological.pdf
25. Downey, A. S., Delaney, L. J., & Morrow, J. B., (2012). *Best practices for sample collection and transport during an initial response to potential biothreat materials* (NIST Technical Note 1776). National Institute of Standards and Technology, U.S. Department of Commerce. doi:10.6028/NIST.TN.1776. Retrieved from <https://nvlpubs.nist.gov/nistpubs/TechnicalNotes/NIST.TN.1776.pdf>
 26. Cheung, S. F., Cheng, S. K., & Kamei, D. T. (2015). Paper-based systems for point-of-care biosensing. *Journal of Laboratory Automation*, 20(4), 316-333. doi:10.1177/2211068215577197
 27. Sajid, M., Kawde, A-N., & Daud, M. (2015). Designs, formats and applications of lateral flow assay: A literature review. *Journal of Saudi Chemical Society*, 19(6), 689-705. doi:10.1016/j.jscs.2014.09.001
 28. Gordon, J., & Michel, G. (2008). Analytical sensitivity limits for lateral flow immunoassays. *Clinical Chemistry*, 54(7), 1250-1251. doi:10.1373/clinchem.2007.102491
 29. Posthuma-Trumpie, G. A., Korf, J., & van Amerongen, A. (2009). Lateral flow (immuno)assay: Its strengths, weaknesses, opportunities and threats. A literature survey. *Analytical and Bioanalytical Chemistry*, 393(2), 569-582. doi:10.1007/s00216-008-2287-2
 30. Li, J., & Macdonald, J. (2016). Lateral flow immunoassays—how fundamental breakthroughs from the 1950s led to the inception of this simple yet powerful tool. *Australian Biochemist*, 47(1), 28-33.
 31. Van Emon, J. M., & Lopez-Avila, V. (1992). Immunochemical methods for environmental analysis. *Analytical Chemistry*, 64(2). doi:10.1021/ac00026a715
 32. Fu, Q., Zhu, J., & Van Eyk, J. E. (2010). Comparison of multiplex immunoassay platforms. *Clinical Chemistry*, 56(2), 314-318. doi:10.1373/clinchem.2009.135087
 33. Director, Operational Test and Evaluation. (2017). Common Analytical Laboratory System - Field Confirmatory - Analytical Capability Set (CALSC-FC-ACS) In *FY 2017 Annual Report* (Rep.). Retrieved from <http://www.dote.osd.mil/pub/reports/FY2017/pdf/other/2017DOTEAnnualReport.pdf>
 34. Kuramitz, H., (2009). Magnetic microbead-based electrochemical immunoassays. *Analytical and Bioanalytical Chemistry*, 394(1), 61-69. doi:10.1007/s00216-009-2650-y
 35. Libert, X., Packeu, A., Bureau, F., Roosens, N. H., & Keersmaecker, S. C. (2017). Development and performance assessment of a luminex xMAP® direct hybridization assay for the detection and identification of indoor air fungal contamination. *PLoS One*, 12(3). doi:10.1371/journal.pone.0173390
 36. Shriver-Lake, L. C., Liu, J., Lee, P. B., Goldman, E., Dietrich, R., Märtilbauer, E., & Anderson, G. (2016). Integrating scFv into xMAP assays for the detection of marine toxins. *Toxins*, 8(11), 346. doi:10.3390/toxins8110346
 37. Carter, J. M., Lin, A., Clotilde, L., & Lesho, M. (2016). Rapid, multiplexed characterization of Shiga toxin-producing *Escherichia coli* (STEC) isolates using suspension array technology. *Frontiers in Microbiology*, 7, 439. doi:10.3389/fmicb.2016.00439

38. Hamza, I. A., Jurzik, L., & Wilhelm, M. (2014). Development of a Luminex assay for the simultaneous detection of human enteric viruses in sewage and river water. *Journal of Virological Methods*, 204, 65-72. doi:10.1016/j.jviromet.2014.04.002
39. Luminex Corporation. (2012, August 9). *Luminex Corporation awarded \$11 million contract by Defense Threat Reduction Agency (DTRA)* [Press release]. Retrieved from <https://www.prnewswire.com/news-releases/luminex-corporation-awarded-11-million-contract-by-defense-threat-reduction-agency-dtra-165630856.html>
40. Reverté, L., Prieto-Simón, B. & Campàs, M. (2016). New advances in electrochemical biosensors for the detection of toxins: Nanomaterials, magnetic beads and microfluidics systems. A review. *Analytica Chimica Acta*, 908, 8-21. doi:10.1016/j.aca.2015.11.050
41. Campuzano, S., Yáez-Sedeño, P., & Pingarrón, J. (2017). Electrochemical affinity biosensors in food safety. *Chemosensors*, 5(1), 8. doi:10.3390/chemosensors5010008
42. Hammond, J. L., Formisano, N., Estrela, P., Carrara, S., & Tkac, J. (2016). Electrochemical biosensors and nanobiosensors. *Essays in Biochemistry*, 60(1), 69-80. doi:10.1042/ebc20150008
43. Bartlett, J. M., & Stirling, D. (Eds.). (2003). PCR Protocols. (2nd ed., Methods in Molecular Biology). Totowa, NJ: Humana Press.
44. Freeman, W. M., Walker, S. J., & Vrana, K. E. (1999). Quantitative RT-PCR: Pitfalls and potential. *BioTechniques*, 26(1), 112-125.
45. Erali, M., & Wittwer, C. T. (2010). High resolution melting analysis for gene scanning. *Methods*, 50(4), 250-261. doi:10.1016/j.ymeth.2010.01.013
46. Navarro, E., Serrano-Heras, G., Castaño, M., & Solera, J. (2015). Real-time PCR detection chemistry. *Clinica Chimica Acta*, 439, 231-250. doi:10.1016/j.cca.2014.10.017
47. BioFire Defense. (n.d.). RAZOR® EX BioDetection System. Retrieved from <http://biofiredefense.com/razorex/>
48. Director, Operational Test and Evaluation. (2017). Next Generation Diagnostic System (NGDS) Increment 1. In *FY 2017 Annual Report* (Rep.). Retrieved from <http://www.dote.osd.mil/pub/reports/FY2017/pdf/other/2017DOTEAnnualReport.pdf>
49. Liu, W., Dong, D., Yang, Z., Zou, D., Chen, Z., Yuan, J., & Huang, L. (2015). Polymerase Spiral Reaction (PSR): A novel isothermal nucleic acid amplification method. *Scientific Reports*, 5(1). doi:10.1038/srep12723
50. Song, J., Liu, C., Mauk, M. G., Rankin, S. C., Lok, J. B., Greenberg, R. M., & Bau, H. H. (2017). Two-stage isothermal enzymatic amplification for concurrent multiplex molecular detection. *Clinical Chemistry*, 63(3), 714-722. doi:10.1373/clinchem.2016.263665
51. Johnson, S. S., Zaikova, E., Goerlitz, D. S., Bai, Y., & Tighe, S. W. (2017). Real-time DNA sequencing in the Antarctic dry valleys using the Oxford Nanopore sequencer. *Journal of Biomolecular Techniques: JBT*, 28(1), 2-7. doi:10.7171/jbt.17-2801-009
52. Castro-Wallace, S. L., Chiu, C. Y., John, K. K., Stahl, S. E., Rubins, K. H., McIntyre, A. B., . . . Burton, A. S. (2017). Nanopore DNA sequencing and

- genome assembly on the International Space Station. *Scientific Reports*, 7(1). doi:10.1038/s41598-017-18364-0
53. Gubala, V., Harris, L. F., Ricco, A. J., Tan, M. X., & Williams, D. E. (2011). Point of care diagnostics: Status and future. *Analytical Chemistry*, 84(2), 487-515. doi:10.1021/ac2030199
54. Martinez, A. W., Phillips, S. T., Carrilho, E., Thomas, S. W., Sindi, H., & Whitesides, G. M. (2008). Simple telemedicine for developing regions: Camera phones and paper-based microfluidic devices for real-time, off-site diagnosis. *Analytical Chemistry*, 80(10), 3699-3707. doi:10.1021/ac800112r
55. Yang, Y., Noviana, E., Nguyen, M. P., Geiss, B. J., Dandy, D. S., & Henry, C. S. (2016). Paper-based microfluidic devices: Emerging themes and applications. *Analytical Chemistry*, 89(1), 71-91. doi:10.1021/acs.analchem.6b04581
56. Mu, X., Xin, X., Fan, C., Li, X., Tian, X., Xu, K., & Zheng, Z. (2015). A paper-based skin patch for the diagnostic screening of cystic fibrosis. *Chemical Communications*, 51(29), 6365-6368. doi:10.1039/c5cc00717h
57. Hirschberg, D. L., Betts, K., Emanuel, P., & Caples, M. (2014). Assessment of wearable sensors technologies for biosurveillance (Edgewood Chemical Biological Center Technical Report No. ECBC-TR-1275). Edgewood Chemical Biological Center. Retrieved from <http://www.dtic.mil/dtic/tr/fulltext/u2/a611718.pdf>
58. Dungchai, W., Chailapakul, O., & Henry, C.S. (2009). Electrochemical detection for paper-based microfluidics. *Analytical Chemistry*, 81(14), 5821-5826. doi:10.1021/ac9007573
59. Caetano, F., Carneiro, E., Agustini, D., Figueiredo-Filho, L., Banks, C., Bergamini, M., & Marcolino-Junior, L. (2018). Combination of electrochemical biosensor and textile threads: A microfluidic device for phenol determination in tap water. *Biosensors and Bioelectronics*, 99, 382-388. doi:10.1016/j.bios.2017.07.070
60. Peeling, R. W., Holmes, K. K., Mabey, D., & Ronald, A. (2006). Rapid tests for sexually transmitted infections (STIs): The way forward. *Sexually Transmitted Infections*, 82(Suppl 5), v1-v6. doi:10.1136/sti.2006.024265
61. Després, N., & Grant, A. M. (1998). Antibody interference in thyroid assays: a potential for clinical misinformation. *Clinical Chemistry*, 44(3), 440-454. Retrieved from <http://clinchem.aaccjnls.org/content/clinchem/44/3/440.full.pdf>
62. Ismail, A.A., Walker, P., Cawood, M., & Barth, J. (2002). Interference in immunoassay is an underestimated problem. *Annals of Clinical Biochemistry*, 39(4), 366-373. doi:10.1258/000456302760042128
63. Vashist, S. K., & Luong, J. H. (2018). Enzyme-linked immunoassays. In *Handbook of immunoassay technologies: Approaches, performances, and applications*. Academic Press.
64. Siemens Medical Solutions. (n.d.). ADVIA Centaur XPT Immunoassay System. Retrieved from <https://usa.healthcare.siemens.com/immunoassay/systems/advia-centaur-xpt/features>
65. Hoorfar, J., Wolffs, P., & Rådström, P. (2004). Diagnostic PCR: Validation and sample preparation are two sides of the same coin. *Apmis*, 112(11-12), 808-814. doi:10.1111/j.1600-0463.2004.apm11211-1207.x

66. Espy, M. J., Uhl, J. R., Sloan, L. M., Buckwalter, S. P., Jones, M. F., Vetter, E. A., . . . Smith, T. F. (2006). Real-time PCR in clinical microbiology: Applications for routine laboratory testing. *Clinical Microbiology Reviews*, 19(1), 165-256. doi:10.1128/cmr.19.1.165-256.2006
67. Quick, J., Loman, N. J., Duraffour, S., Simpson, J. T., Severi, E., Cowley, L., . . . Carroll, M. W. (2016). Real-time, portable genome sequencing for Ebola surveillance. *Nature*, 530(7589), 228-232. doi:10.1038/nature16996
68. Hoenen, T., Groseth, A., Rosenke, K., Fischer, R. J., Hoenen, A., Judson, S. D., . . . Feldmann, H. (2016). Nanopore sequencing as a rapidly deployable Ebola outbreak tool. *Emerging Infectious Diseases*, 22(2). doi:10.3201/eid2202.151796
69. Faria, N. R., Quick, J., Claro, I., Thézé, J., Jesus, J. G., Giovanetti, M., . . . Pybus, O. G. (2017). Establishment and cryptic transmission of Zika virus in Brazil and the Americas. *Nature*, 546(7658), 406-410. doi:10.1038/nature22401

3**Biologically-based Toxicity Sensors for Detection of Chemicals in Drinking Water**

Mark Widder, USACEHR

Theresa Curtis, State University of New York at Cortland

Lisa Cazares, USAMRIID

Linda Brennan, USACEHR

John Lewis, USACEHR

David Trader, USACEHR

Courtney Morrell, USAMRIID

Ernst Brueggeman, USAMRIID

Tara Kenny, USAMRIID

Michael Ward, USAMRIID

William Dennis, USACEHR

Satori Thomas, Hood College

Nicolette Henning, University of Maryland

William van der Schalie, ORISE

Valerie DiVito, USACEHR

Overview

The Department of Defense (DoD) has a capability gap regarding the rapid detection of the presence of toxic chemicals in drinking water. Analyte-specific chemical detectors currently in use by DoD fail to detect threats from the full range of materials that can contaminate water, food, or air, especially threats associated with novel or unknown materials or chemical mixtures. In an effort to address this gap, the Environmental Sentinel Biomonitor (ESB) system was developed and is scheduled to be fielded in FY19. The ESB consists of biologically-based toxicity sensors that provide an important complement to current Army-fielded chemical detectors, such as the Water Quality Analysis Set – Preventive Medicine (WQAS-PM), by providing a rapid (under one hour) qualitative response (yes or no) to the presence of harmful chemicals. The ESB includes two toxicity sensor components: a) an electric cell-substrate impedance sensing (ECIS) device that measures changes in electrical characteristics of a monolayer of rainbow trout gill epithelial (RTgill-W1) cells grown on fluidic biochips and b) a pesticide sensor (the ACE™ Rapid Test for Acetylcholinesterase Inhibitors, or ACE™ test) that measures enzyme inhibition caused primarily by organophosphorus and carbamate compounds. In this section, we focus on the development of the ECIS cell-based sensor and efforts underway to improve the sensitivity, specificity, and predictive value of the ECIS device. Some of these efforts include identifying molecular indicators of toxicity via metabolomic, proteomic, and transcriptomic interrogation of exposed RTgill-W1 cells. The addition of appropriate indicators identified using multi-omic techniques into the next generation of the ESB device may allow toxicological pathway identification and rapid classification of unknown materials. We will also discuss the challenges of using cell-based sensors for monitoring field water, describe other cell lines that have been tried with ECIS, and review recent advances in cell-based sensors that could provide future improvements for this

technology. With further development, biologically-based toxicity sensors may offer significant advantages for detection of a wide range of toxic chemicals in water, including novel or unsuspected chemicals or chemical agents.

1. Introduction

The broad range of chemicals that may be introduced (accidentally or purposefully) into water, food, or air pose a difficult problem for detection systems. This is especially true for chemical agents, which may involve novel or unsuspected materials or mixtures that may have unique toxicological properties. Analytical chemistry instrumentation suitable for rapid assessment of a broad range of chemical contaminants (e.g., gas and LC and mass spectrometry) tends to be complex and expensive, limiting the potential for field use. An alternative approach is to use a toxicity sensor that measures the response of a biological indicator to the presence of toxic chemicals. Although there are analyte-specific biosensors (e.g., those that use antibodies, enzymes, and nucleic acids for detection of particular chemicals in water [1–4]), a large number of these biosensors would be required to detect the broad range of potential contaminants [5]. For this reason, the use of biologically-based toxicity sensors can be an effective complement to traditional analytical chemistry methods.

Many different broad-based toxicity sensors have been developed with biological components, ranging from enzymes to whole organisms [1, 6–9], but they all present advantages and challenges. A significant advantage is the ability to respond rapidly to a broad range of chemical contaminants, including unknown or unsuspected materials and chemical mixtures [10]. In addition, toxicity sensors can provide a direct indication of potential biological effects in a way that analytical chemistry methods cannot [1], and cell-based sensors may be helpful in evaluating the bioavailability of contaminants [11]. While toxicity sensors can respond to a wide range of contaminants, they cannot identify the specific chemical or chemicals causing the response. Further, because toxicity sensors include biological components, special storage requirements may be needed for test consumables (e.g., varying degrees of temperature control), and shelf life, even with temperature control, may be limited.

In this section, we illustrate a practical use of toxicity sensors for military applications with the example of Army field water supply testing. Military personnel deployed around the world require high quality drinking water, and outlined procedures are used to ensure that military field water supplies are properly treated and monitored [12]. Chemical contaminants pose potential threats to personnel who consume drinking water in the field [13], and although existing water treatment technology is highly efficient, removal of contaminants may be inadequate if chemicals are present in source waters at high concentrations or if the chemicals are introduced (either intentionally or accidentally) after processing. U.S. Army preventive medicine personnel periodically test water supplies using the WQAS-PM and associated equipment, which includes field tests for a limited number of specific chemicals of concern. While water supplies can be evaluated more thoroughly at offsite laboratories, these evaluations are done infrequently and are more costly. Typically, these analytical test results are not available for days or weeks.

In developing a toxicity sensor to meet U.S. Army needs for the testing of field drinking water supplies, it was necessary to evaluate available toxicity sensor technologies within the constraints of Army requirements, which are described in a formal Army Capability Development Document (CDD) [14]. The proposed toxicity detection device, the ESB system, needs to detect a broad spectrum of toxic industrial chemicals (TICs) (as described below) and be field-portable, and its biological components should have a shelf-life of at least nine months; refrigeration, but not freezing, of perishable components, is permitted. Finally, the ESB system must satisfactorily perform in an independent laboratory evaluation using procedures developed for the U.S. Environmental Protection Agency's (EPA) Technology Testing and Evaluation Program (TTEP) [15].

The Army CDD requires the ESB to detect at least 50 percent of a diverse set of 18 chemicals within two hours. For a given chemical, the ESB must respond to concentrations in a water sample that exceeds the seven- to 14-day military exposure guideline (MEG) levels, assuming an individual water consumption rate of 15 liters (L) per day, which is typical of arid environments [16]. The upper limit for a useful toxicity sensor response is defined as the estimated human lethal concentration (HLC) [17]—the concentration of a chemical estimated to be toxicologically lethal to an individual weighing 70 kilograms (kg) who consumes 15 L of water in a day. While these test chemicals include diverse substances with varying modes of toxic action, they are not intended as the sole focus for ESB detection; rather they are a small subsample of a much larger set of potential threat chemicals to which the ESB might respond.

In addition to the toxicants, several potential interfering materials were included in the test set. These are materials found in natural waters that, although not toxic, may cause a response in a toxicity sensor. Potential interferences include chemicals commonly used for drinking water disinfection (e.g., chlorine and chloramine) and plant decomposition products (humic and fulvic acids) found in certain source waters. Hard water (water high in calcium and magnesium and their associated anions) was also included because of the potential sensitivity of some biological systems.

Given the large number of available toxicity sensor devices and the constraints imposed by Army field use requirements, it was clear that a downselection process was needed. A formal decision analysis approach was used for this purpose; both Army users and a toxicity sensor expert panel participated in the evaluations [18]. An initial downselection of 38 technologies led to comparative response testing of 12 toxicity sensors [19] to a select list of representative chemicals with different modes of toxic action that could possibly be found in source or product drinking water. These sensors did not adequately detect the pesticides in this select list of chemicals (specifically, organophosphate and carbamate chemicals). To address this need, a separate downselection of six pesticide assays was performed with an expanded set of pesticides [20]. After collection of additional technical data on several of the highest scoring sensors, selected for inclusion in the ESB system were the best performing sensors; a cell-based ECIS test produced by Nanohmics, Inc.; and the ACE™ enzyme inhibition test from ANP Health, Inc. [18]. Two toxicity sensors were included in the ESB to provide a toxicity response to the broadest range of chemicals while minimizing the technical complexity, size, weight, and cost of the system.

The ECIS test monitors alterations in the electrical impedance of a monolayer of rainbow trout gill epithelial cells (RTgill-W1) to indicate toxicity due to chemical contamination [21]. In the ECIS sensor, the RTgill-W1 cells are grown on fluidic biochips. Cells are seeded in two separate fluidic channels on the biochip containing electrodes; during testing, one channel is dedicated to the control sample while the other is dedicated to the test sample. When the integrity of the cell monolayer is compromised through contact with a toxic chemical, the ECIS sensor records a change in electrical impedance. Toxicity of a water sample is indicated when the impedance response in the control channel differs significantly from the test channel during a one-hour exposure period. ECIS biochips can be maintained for at least nine months at 6 degrees Celsius with no media replacement. The biochips are 9 centimeters (cm) x 4 cm x 1 cm, while the ECIS sensor is 33 cm x 25 cm x 12 cm and weighs 5 kg. The sensor has an internal, rechargeable battery and can function on battery power or with standard 110 or 220 volt (V) power.

The test chemicals and the ECIS responses at the HLC for are summarized in Table 1, as generated during the EPA TTEP evaluation conducted by an independent laboratory [22]. Although the ECIS test responded to only seven of the 18 chemicals at the HLC, the ESB response exceeds CDD requirements when the ACE™ test (described below) is included. The primary ECIS response to interfering substances was observed for 10 milligrams (mg)/L chloramine, with no response at 5 mg/L [22].

Test Chemicals	HLC* (mg/L)	ECIS Response?
Acrylonitrile	4.2	No
Aldicarb	0.17	No
Ammonia	924	Yes
Arsenic (sodium arsenite)	4.5	No
Azide (sodium azide)	47	Yes
Copper (sulfate)	71.9	No
Cyanide (sodium)	14	Yes
Fenamiphos	0.56	No
Fluoroacetate (sodium)	5.1	No
Mercury (chloride)	24.7	Yes
Methamidophos	1.4	No
Methyl parathion	33.6	Yes
Nicotine	16.8	No
Paraquat (dichloride)	4.6	No
Pentachlorophenate (sodium)	71.9	Yes
Phenol	91.5	No
Thallium (sulfate)	13.5	No
Toluene	840	Yes
*HLC – Human lethal concentration (70 kg person, 15 L/day)		

Table 1. ECIS response to toxicants at the estimated HLC [22]

In practice, water samples for ESB testing are dechlorinated prior to ESB testing, so drinking water disinfection chemicals should not be present. The ECIS was not highly sensitive to other potential interferences tested (water hardness and humic/fulvic acids), and Army drinking water is typically produced using reverse osmosis and other processes that should remove these materials from the water. If untreated source waters must be evaluated, it would be best to first establish a baseline of tests to demonstrate interferences that could lead to false positives. The ACE™ test, which is intended to evaluate a water sample in parallel with the ECIS test, is an approximately one-hour enzymatic assay designed to detect neurotoxicants (specifically, cholinesterase-inhibiting compounds, such as organophosphate and carbamate pesticides). It uses the reactions of stabilized carboxyl esterase (CE), acetylcholinesterase (AChE), and a reporting chemical that fluoresces under UV light [23].

During testing, control and test water samples are added to separate vials containing either AChE or CE, followed by a 30-minute waiting incubation period. Then, the sample-enzyme mix is added to a test ticket well containing a substrate that fluoresces after being cleaved if active enzyme is present. After 15 minutes, the ticket is read under ultraviolet light. Any interference with enzyme function will result in distinct differences in hue between the control and test ticket wells. Test tickets and enzymes are stable for at least 9 months at room temperature. The test tickets are 7 cm x 2 cm x 0.5 cm. The ACE™ test unit is 11 cm x 17 cm x 8 cm and weighs 0.7 kg. The ACE™ test reader operates on either an internally rechargeable lithium ion battery pack or standard 110 or 220 V power.

The ECIS and ACE™ tests are contained together in an ESB carrying case; the ECIS fluidic biochips, which require temperature control for long-term viability, can be transported in small, insulated containers, such as the Golden Hour™ Series 4 (Pelican BioThermal, Plymouth, MN). (See Figure 1—note that the temperature-controlled insulated container that would hold the ECIS biochips is not pictured.)



Figure 1. ECIS (instrument on the left) and ACE™ (instrument on the right) sensors with reusable supplies packaged in the ESB carrying case.

Although we have included a description of the ACE™ sensor here, the main focus of this section is to evaluate two efforts to improve the ECIS portion of the ESB system. The first effort is an on-going evaluation of alternative cell lines and biomarkers to increase the sensitivity and predictive value of the ECIS test. The second effort involves improvements to the ECIS test based on feedback from Army user testing and evaluation events. Selecting an appropriate cell line for use in the ECIS test has been a key challenge in developing the ECIS test for Army field use. Cell line requirements include sufficient sensitivity to toxicants of Army concern, and the potential for a long shelf life without the need for media replacement or support equipment not already available to Army preventive medicine personnel.

The RTgill-W1 cell line used in the ECIS device has adequate sensitivity to many chemicals of concern to the Army and can be held in fluidic chips for up to nine months with no media changes and without supplemental carbon dioxide when stored at 6 degrees Celsius (a field refrigerator is already available to preventive medicine personnel as part of the WQAS-PM kit) [5]. However, the RTgill-W1 cells are insensitive to some chemicals (e.g., AChE-inhibiting chemicals), which is the reason for the inclusion of the ACE™ test in the ESB. To improve ECIS toxicant sensitivity while retaining the long-term storage capabilities of the RTgill-W1 cell line, we evaluated a number of alternative mammalian and non-mammalian cells lines. And, while recognizing that epithelial cell lines, such as RTgill-W1, may not be as sensitive to some classes of toxicants as other cell lines (e.g., as some neuronal cells are to AChE-inhibiting toxicants), we sought to expand the sensitivity and predictive value of the RTgill-W1 cells by identifying molecular indicators of toxicant response that could be incorporated into the ECIS test.

To find relevant biomarkers of toxicity that could be integrated into a next-generation ECIS assay, we initiated a collaborative effort to evaluate the short-term metabolomic, proteomic, and transcriptomic responses of RTgill-W1 cells to a range of military-relevant toxicants. Here, we report on preliminary data that are available from metabolomic testing only. When the data analyses are completed, we will report on the proteomic and transcriptomic results and an integrative bioinformatics effort to identify potential biomarkers that could be incorporated into the ECIS test.

Metabolomics is emerging as the dominant approach in systems biology studies and is extensively employed in biomedical, pharmaceutical, and toxicological research. The metabolome of a system includes small molecular building blocks (e.g., nucleotides, sugars, and amino acids), metabolic intermediates (e.g., fatty acids), and structural-signaling elements (e.g., lipids). Metabolite profiling is often implemented to search for new diagnostic markers in body fluids and tissues as the data collected represents the dynamic perturbations of the genome, transcriptome, and proteome. Alterations in metabolite levels are generally more rapid than changes in protein or nucleic acid abundances. Therefore, metabolomics has the potential to aid in the identification of biomarkers indicative of toxic effects and facilitate the construction of models for toxicity prediction as well as patterns of metabolite response specific for each toxicant class.

Among analytical techniques, NMR spectroscopy and mass spectrometry provide the richest information about the metabolome. Spectroscopy (¹H NMR) is

reproducible for measuring many low molecular weight metabolites, although it is often limited by its relatively low sensitivity (milli- to micromolar levels) [24]. In contrast, mass spectrometry can simultaneously analyze thousands of metabolites in a biological sample and is the current method of choice in metabolomics studies due to its unprecedented mass resolving power and sensitivity [25]. For example, a recent publication described the use of LC-mass spectrometry/mass spectrometry-based metabolomics profiling of cultured human derived hepatic cells after exposure to compounds with known hepatotoxicity [26]. This *in vitro* platform uncovered toxicant specific metabolomic fingerprints associated with oxidative damage, steatosis, and phospholipidosis in liver cells. These signatures were then used to develop a model to screen and classify hepatotoxicity based on a toxicants mode of action.

Whereas homogenization-based sample preparation and extraction methods result in a loss of spatial information, Matrix Assisted Laser Desorption Ionization Imaging Mass Spectrometry (MALDI-IMS) adds another dimension of information to metabolite profiling by providing *in situ* snapshots of the spatial distribution of biologically relevant metabolites in intact tissue samples [27]. MALDI-IMS is a label-free technology that can be used without prior knowledge of sample composition, allowing for the detection of a variety of analytes, from small molecules to proteins. MALDI mass spectrometry uses a matrix, typically a small organic acid with strong ultraviolet absorbance, to aid desorption and ionization of analytes. The resulting gas phase analyte ions are detected and displayed in a spectrum according to their mass-to-charge ratios (m/z), which yield specific molecular signatures within complex samples.

Recent improvements in mass spectrometry imaging instrumentation platforms related to higher mass accuracy and improvement of spatial resolution have facilitated the identification of metabolite molecules directly from tissue sections and cellular monolayers without further concentration or purification. This includes the coupling of MALDI ionization to a Fourier Transform Ion Cyclotron Resonance (FT-ICR) mass spectrometry, which offers the highest level of mass accuracy (<1 part per million [ppm]) and resolution necessary for identification of low molecular weight metabolites [28]. Therefore, MALDI-FT-ICR-IMS was employed for the identification of dysregulated metabolites directly from RTgill-W1 cells in the ESB device after exposure to DoD-relevant toxicants. Metabolites that are changed after exposure will be connected to known metabolite pathways using available databases (i.e., Kyoto Encyclopedia of Genes and Genomes database). When completed, the addition of transcriptomic and proteomic data will hopefully provide broader knowledge about the perturbed pathways.

Finally, in addition to ESB laboratory toxicity testing, it was critical to obtain real-world performance information as well as user feedback from Army preventive medicine personnel who would be using the ESB in the field. Evaluations included environmental testing, a customer assessment, and field performance testing. Results reported here emphasize the ECIS test, as much of the feedback concerned this method.

2. Methods

2.1 Cell Line Selection

When screening a new cell line, cells were first seeded in ECIS open well chips to determine if a cell layer could form that yielded an impedance greater than 1,000 ohms. Cell seeding was performed according to previously published methods [29]. Briefly, 8W10E chips (Applied BioPhysics, Troy, NY, USA) were coated with different adhesion substrates (e.g., gelatin, fibronectin, collagen, laminin, or polylysine) and were then seeded with cells. The seeded open well chips were stored for a two-week period at the optimal culture temperature, during which time the cell-line specified media was replenished three times per week and impedances were recorded as indications of the cellular monolayer integrity. Impedance of cell monolayers grown on ECIS chips was monitored using the ECIS 1600 analyzer (Applied BioPhysics). A cell monolayer was considered to be stable over the two-week storage period if the impedance values did not decrease by more than 20 percent and if the morphology of the cells did not change substantially as visualized by phase contrast microscopy. Twenty percent was set as the largest acceptable reduction in impedance from the starting monolayer value based on previous experiments using confluent cell monolayers for toxicity testing [5, 29-30]. For the system to be sensitive to chemical toxicity, a significant difference in impedance between the healthy and affected cells needed to be established and maintained.

Cell lines would be considered as potential candidates for fluidic biochip use in a field-deployable ECIS sensor if: (a) they could form stable monolayers with high impedance readings for 37 days, (b) had increased sensitivity to the selected toxicants over cell lines currently being used in ECIS open-well chips, and (c) if they did not require exogenous carbon dioxide (CO₂), frequent cell media replacement, or greater than average room temperature incubation [29, 31]. In order to initiate the ECIS toxicity testing with different cell lines on the open-well chips, the growth media was removed from the wells containing the cells and temperature-acclimated, serum-free media was added to each well for one hour. Selected chemicals were dissolved in serum-free media at desired concentrations and temperature acclimated during this time. After one hour, the serum-free media was removed from the wells, and the test chemicals in media were added. The toxicant exposures were for one hour, during which time impedance readings were taken on all the wells and a curve discrimination program analyzed the results. All tests were conducted in environments that were conducive to that particular cell line (temperature and CO₂ level appropriate) [29].

To determine if cell lines were stable in a field portable ESB system, cells were seeded within enclosed fluidic biochips (Nanohmics, Inc.) and stored for a minimum of three months with no media replenishment. The biochips have two fluidic channels, each containing four pads of sensing electrodes with 10 sensing electrodes on each pad. For cell testing on the fluidic biochips, the chips were first coated with selected adhesion substrates determined by optimization performed on the open well ECIS chips, then the cells were seeded at densities of 2–5 × 10⁵ cells/milliliter, depending upon the cell type. Sterile PharMed® BPT (Cole Palmer, Vernon Hills, IL) was used to form closed loops on the ends of the biochips. The seeded biochips were stored at the optimal growing temperature for the cells and fed with growing medium three times a week over a one to two week initial feeding

period to allow the cells to form a confluent monolayer inside the biochip. The chips were then placed in different temperature environments to examine long-term (>90 days) cell viability in a variety of environmental conditions [10]. The cells in the fluidic biochip were not fed during the maintenance period. Viability of the monolayer was determined by monitoring impedance values over the storage time. As with the open well chips, to be characterized as sustainable in the field, a cell line must be able to maintain a stable impedance reading (less than 20 percent reduction) over a minimum of three months in the enclosed fluidic biochip. Figure 2 demonstrates the principles of electric cell substrate impedance sensing.

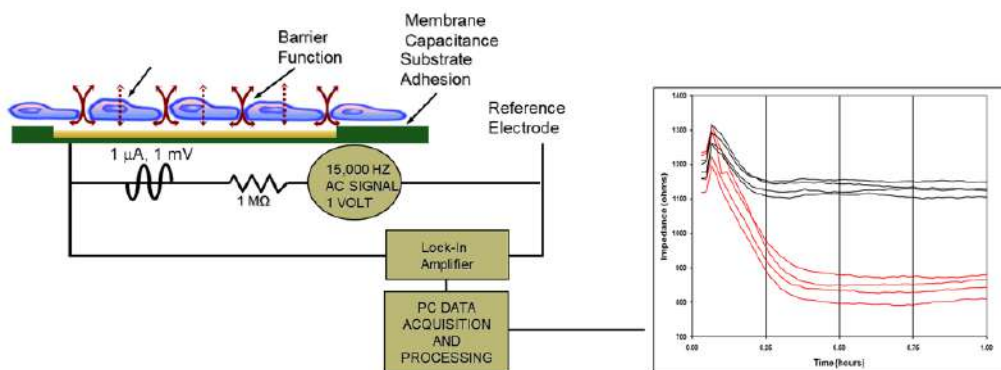

Figure 2. Principles of Electric Cell Substrate Impedance Sensing (ECIS)

2.2 Omics Evaluation for ECIS Biomarker Identification

The overall research approach taken to explore the possibility of improving the sensitivity of the ECIS fluidic biochip seeded with RTgill-W1 cells is outlined in Figure 3. Chemical concentrations for these tests were chosen based on previous ECIS response data with the inclusion of MEG and HLC data so that the results would provide relevant information for the Army's needs for field testing of drinking water. To evaluate metabolomics endpoints, ECIS biochips were exposed to the suite of historically tested chemicals for the required one hour time period and the ECIS results recorded.

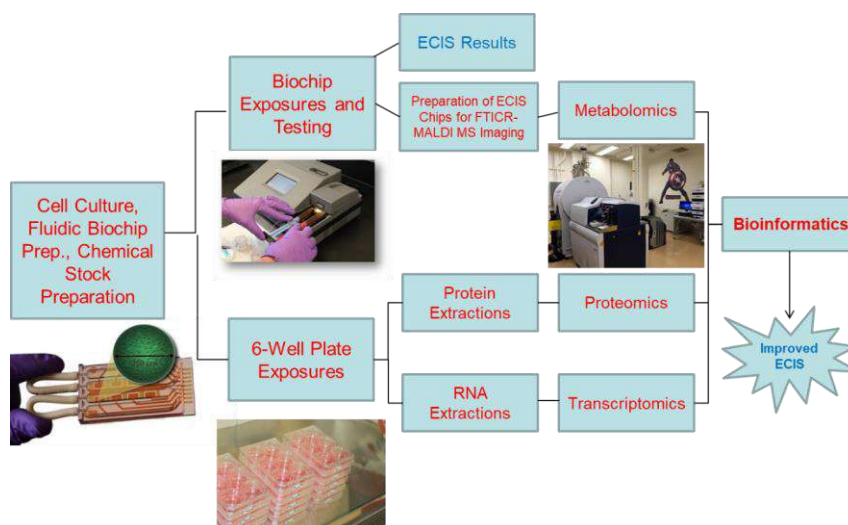

Figure 3. Workflow of ECIS/Omics Testing Approach

The same chips were then used for analysis of metabolomics. For proteomics and transcriptomics analysis, RTgill-W1 cells were seeded in six-well tissue culture plates and were exposed to the same chemicals and test concentrations as the biochips. Other than the testing environment (i.e., fluidic biochips vs. six-well plates), the other difference between omic analyses was that only two test concentrations of each test chemical were used for the biochip exposures, while four test concentrations were used for six-well plates. A total of 15 toxicants along with three common water interferences that were historically tested for ECIS toxicity with the RTgill-W1 seeded biochips were used. Table 2 outlines the concentrations of chemicals used for the ECIS, metabolomic, proteomic, and transcriptomic tests.

	All concentrations are in mg/L ¹					
Chemicals	MEG ²	HLC ³	Conc. 1	Conc. 2	Conc. 3	Conc. 4
Acrylonitrile	0.47	4.2	0.47	4.2	42	405
Ammonia	30	924	8.2	30	110	400
Arsenic	0.02	4.5	0.02	0.12	0.74	4.5
Azide	0.36	30.2	0.36	1.2	3.6	12
Copper	0.047	103	0.047	0.47	4.7	47
Cyanide	2	14	0.76	2.0	5.3	14
Fluoroacetate	0.002	3.9	0.002	3.9	44.2	500
Mercury	0.031	24.7	0.031	0.1	0.31	1
Methyl parathion	0.14	33.6	0.14	0.75	4.0	21.4
Nicotine	0.13	16.8	0.013	16.8	168	1000
Paraquat	0.034	4.6	0.034	4.6	46	460
Pentachlorophenol	0.14	71.9	0.033	0.14	0.59	2.5
Phenol	2.8	91.5	2.8	91.5	183	368
Thallium	0.0033	13.5	0.0033	1.35	13.5	135
Toluene	9.3	840.0	1.63	9.3	53	300
Interferences⁴						
Humic/fulvic acid	NA	NA	1.25/1.25	2.5/2.5	5.0/5.0	
Chlorine	NA	NA	1.25	2.5	5	10
Hardness (CaCO ₃)	NA	NA	31	62	125	250
¹ Concentrations 1,2,3 and 4 were used for proteomics and transcriptomics.						
Concentrations in blue shading used for ECIS and metabolomics.						
² The Military Exposure Guideline (MEG) concentration is considered to be a threshold above which adverse health effects may occur if a soldier were to consume 15 L of water per day for 7-						
³ The Army Human Lethal Concentration (HLC) is a toxicological lethal concentration based on consuming 15 L of water per day for a 70 kg person.						
⁴ Interferences are common components found in drinking water that are not considered toxic, therefore, ECIS detects would be undesirable.						

Table 2. Chemical Concentrations for Toxicity Testing

2.2.1 ECIS

Since both the ECIS and metabolomic data were obtained from the ECIS chips, metabolomic data could be compared to the ECIS response data from the same biochip. On the test day, pre-measured aliquots of L-15ex powdered media (US Biological, Inc., Salem, MA) were added to control water and chemical test concentrations to maintain the osmotic balance for the cells. In order to expose the RTgill-W1 cells to the test chemicals for both ECIS and metabolomics exposures, one channel of the biochip was designated for a control and the other for an unknown or test sample. Six biochips were used per chemical (three biochips per concentration/two concentrations per chemical) [10].

Figure 4 depicts the seeded biochip in the ECIS sensor with an exploded view of the monolayer of RTgill-W1 cells on the sensing electrode, and Figure 5 demonstrates the injection of the water samples into the biochip to initiate the one-hour test. After the one-hour exposure, the ECIS reader would register a “contamination detected” or “no contamination detected” response to the toxicity test. This result is derived from measured changes in electrical impedances of the cell monolayers in the control and test channels based on algorithms developed specifically for this purpose. After test results were recorded, the biochip was removed for metabolomics processing.

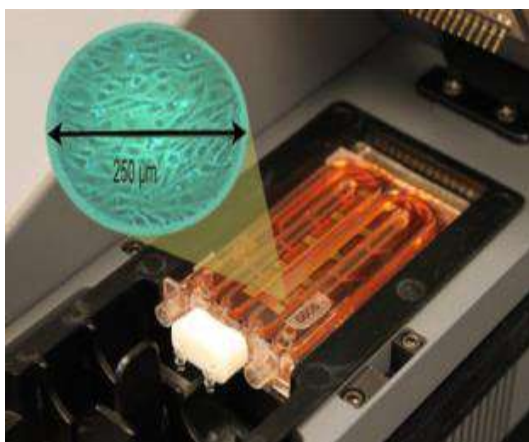

Figure 4. Seeded fluidic biochip in place in the ECIS sensor; cutout view of one sensing electrode with a monolayer of RTgill-W1 cells



Figure 5. Simultaneous injection of control water (blue syringe) and test water sample (red syringe) for initiation of the ECIS test

2.2.2 Metabolomics

After recording the ECIS information from the chemical exposure, the test media was removed from each channel of the biochip and channels were rinsed with ammonium formate (pH 8.0), followed by a one-minute fixation of the cells with 4 percent paraformaldehyde to prevent metabolite breakdown. The outer-plastic housing of the device was then removed, and the internal plate that houses the fluidic channels where the RTgill-W1 cells were seeded was coated with MALDI matrix 9-amino acridine using a commercial spraying device (HTX T1 Spray Chamber, HTX Technologies, Carrboro, NC). This matrix formulation provides robust efficiency for the ionization of important cellular metabolites at attomole levels in the cellular monolayers [32]. After matrix deposition, the biochip was then

affixed to the MALDI target using double sided-tape, and three areas of the RTgill-W1 monolayer growing on the control or exposed fluidic chamber were interrogated directly via FT-ICR-MALDI-IMS. This imaging/profiling experimental strategy does not require metabolite extraction; therefore, it should provide a more accurate snapshot of metabolite levels after toxicant exposure. All metabolites were identified by accurate mass match of obtained high resolution FT-ICR m/z values to the Metlin database of metabolites [33]. High mass accuracy, using a mass tolerance of 1 ppm, was then used to filter the discriminate peaks and assign provisional identifications. To calculate statistical differences of metabolite peak abundance between control and exposed cells, 200 random spectra from each region were selected for discriminant analysis, and normalization to total ion current was performed to standardize intensity levels across multiple ECIS chips. Additionally, to ensure that the drop in abundance of metabolite molecules was not due primarily to cell death, cell viability determinations were made after test chemical exposure.

2.2.3 Proteomics and Transcriptomics

Standard tissue-culture six-well plates (Fisher Scientific, Pittsburgh, PA) used for transcriptomic and proteomic assays were seeded with RTgill-W1 cells at the same time as the biochips being used for ECIS and metabolomics. Five replicate six-well plates were used per chemical with each plate containing a control well and four wells of test concentrations (see Table 2). After cell seeding occurred, the six-well plates were held at 20 degrees Celsius for seven days, with media replenishment occurring on days four and seven. After day seven media replenishment, the plates were then held at 6 degrees Celsius until the day of test. Sterile culture technique was maintained for the six-well plates during the seeding, feeding, and cold storage time frames.

On the test day, pre-measured aliquots of L-15ex powdered media (US Biological, Inc.) were added to control water and chemical test concentrations to maintain the osmotic balance for the cells. The plates were removed from 6 degrees Celsius and received either control or test chemicals and were then held at room temperature for one hour. At this point, sterile culture technique was no longer needed. After one hour of exposure, the 6-well plates were processed for proteomics and transcriptomics.

2.2.3.1 Proteomics

After exposure, the media was removed and the cells were rinsed with phosphate-buffered saline and lysed. Proteins were purified, digested with trypsin, and the peptides were labelled using tandem mass tags [34]. Peptides derived from each control and toxicant treated sample (at different concentrations) were labelled with a different mass tag, and mixed together for a single LC-MS/mass spectrometry run. Using the control sample as a baseline for protein abundance levels in the RTgill-W1 cells should provide both protein identification and abundance changes after toxicant exposure.

2.2.3.2 Transcriptomics

After exposure, the media was removed from the wells, Buffer RLT (Qiagen, Hilden, Germany) containing β -mercaptoethanol was added to each well and pipetted up and down for lysing of cells. The lysate was transferred to RNase-free microtubes, vortexed, and put on ice until all plate processing was completed. The

tubes were transferred to a -80 degrees Celsius freezer until ready for shipment for transcriptomic analysis.

2.3 ESB/ECIS Field Testing

2.3.1 Environmental Testing

Army medical equipment such as the ESB system is required to pass field-relevant environmental testing administered by the U.S. Army Medical Research and Materiel Command Test Branch, following Military Standard (MIL-STD) 810G—Environmental Engineering Considerations and Laboratory Tests [35]. The following tests were conducted on both the ACE™ and ECIS instruments, using procedures described in MIL-STD 810G [36]. Operational tests refer to active testing with the ACE™ and ECIS under the specified test conditions; non-operational refers to storage under the specified test conditions, with testing performed under room temperature conditions. Testing was conducted using a positive control water sample (4.9 g/L sodium chloride for ECIS; 20 mg/L copper for ACE™).

- Low temperature, operational (15 degrees Celsius) and non-operational (0 degrees Celsius)
- High temperature, operational (45 degrees Celsius) and non-operational (71 degrees Celsius)
- Altitude (4,572 meters equivalent), operational and non-operational
- Settling dust and sand (settling for one hour on exposed equipment), non-operational
- Ground vibration (1.90 root-mean-square acceleration for one hour), non-operational
- Transit drop (ESB packaged in its case was dropped from a height of 4 feet onto a steel surface)
- Loose cargo transportation, non-operational (ESB packaged in its case was vibrated at 300 revolutions per minute, 2.5 cm amplitude for one hour)

2.3.2 Field Testing

Several field evaluations of the ESB system were conducted. The U.S. Army Medical Department (AMEDD) Board conducted a customer assessment to determine if the ESB system would support the preventive medicine mission and if it was usable in an operational environment [37]. In this assessment, following a four-hour familiarization period with the equipment, six teams of Army preventive medicine specialists and an environmental science and engineering officer used the ESB system in an operational environment to process blind water samples that were either negative or positive controls (ECIS – 300 mg/L ammonia; ACE™ – 20 mg/L copper). Operation was tested using commercial power (120 volts [V] AC), generator power (220V AC), and internal battery power. AMEDD Board staff then evaluated ESB system performance against operationally-relevant criteria, including whether its functionality supported the preventive medicine mission, whether it was usable in an operational environment, whether the ESB system posed any safety hazards, and if it was operational after transport over a variety of terrains.

Additional field evaluations were conducted with only the ECIS component of the ESB system to further characterize its operation and performance. Preventive

medicine personnel at the 1st Area Medical Laboratory (1st AML), Aberdeen Proving Ground conducted additional ECIS testing using control samples only. A subsequent round of field testing was performed to verify and validate system performance. These ECIS tests were conducted with blind water samples (negative and positive controls; positive controls were either 4.5 mg/L arsenic or 2.5 mg/L pentachlorophenate). Evaluations were performed at the Air Force Medical Evaluation Support Activity (AFMESA) field site, Fort Detrick, MD, by preventive medicine personnel from the 1st AML. Samples tested included 28 negative controls and eight positive controls (four arsenic, four pentachlorophenate).

In addition to these ECIS-specific tests, the ESB system (both ECIS and ACE™) was evaluated by the 227th Medical Detachment (Preventive Medicine) in a deployed environment at Camp Taji, Iraq, and Camp Arifjan, Kuwait. In this evaluation, two ESB units along with consumables were shipped from the U.S. to Kuwait. The theater biochemist coordinated testing and evaluation by 18 participants (preventive medicine personnel), who completed a total of 20 water tests (eight ECIS and ACE™ tests at Camp Taji; 12 ECIS tests at Camp Arifjan). For these tests, the positive controls were 6,000 mg/L sodium chloride (ECIS) and vinegar (ACE™). Participants were asked to fill out a customer assessment form regarding their experiences with the ESB system.

3. Results and Discussion

3.1 Cell Line Selection

Table 3 summarizes the performance of various cell types in open well and fluidic ECIS chips. None of the invertebrate cells could form a monolayer that yielded impedance values greater than 1,000 ohms. The HvAM1 cells had the highest impedance values (900 ohms) of all the invertebrate cell lines tested, but the cell monolayer became clumpy over the two-week period, causing the impedance values to drop.

The vertebrate non-mammalian cell lines were each chosen because of their ability to be maintained at different temperatures. As summarized in Table 3, most of the vertebrate cell lines formed a stable monolayer on the open well ECIS electrodes and yielded high impedance values. The cell lines that were not stable for two weeks were not contact inhibited, so the cells began to layer on top of one another, resulting in decreased impedance values. Many of the non-mammalian vertebrate cell lines formed monolayers, had test-worthy impedance values, and were sustainable for longer periods of time in the fluidic biochip—but only when they were stored at the lower end of the organism's core temperature.

Mammalian cells mostly required frequent feedings, a 37 degrees Celsius heated environment, and exogenously supplied CO₂ if not fed on a daily basis, making them unsuitable for use under field conditions. The 15P-1 cell line (Sertoli cells isolated from mouse testis) was the one mammalian cell line that could be stored at temperatures other than 37 degrees Celsius. The 15P-1 cells were stable for two weeks at the optimal growth temperature (32 degrees Celsius) and also at room temperature in the open well ECIS chips without exogenously added CO₂, but these cells did not maintain a stable monolayer in the enclosed fluidic biochip.

Table 3. Field suitability of cell lines for use in the ECIS system

“X” = unsuitable “√” = acceptable

Animal Origin (Common Name)	Cell Line/Type	Formation of Stable Cell Monolayer ^a	High Impedance (> 1000 Ω)	Field Sustainability ^b	Preliminary Toxicant Screening ^c	Cell source, Reference
Vertebrate Mammalian						
Cow	Lung microvessel endothelial cells (BLMVEC)	√	√	X	√	VEC Technologies, [29]
Cow	Pulmonary artery endothelial cells	√	√	X	√	VEC Technologies, [29]
Human	Lung epithelial cells (A-549)	√	√	X	√	ATCC, Curtis 2012 unpublished
Human	Keratinocyte (primary)	√	√	X		Cambrex Bio Science, [29]
Human	Bronchial epithelial cells (BEAS-2B)	√	√	X		ATCC, Curtis 2009 unpublished
Human	Umbilical vein endothelial cells (HUVECs)	√	√	X	X	VEC Technologies, [29]
Green monkey	Kidney (Vero)	√	√	X	X	ATCC, [29]
Human	Cortical neuron (HCN-2)	√	X	X		ATCC, Curtis 2009 unpublished
Human	Intestinal epithelial cells (Caco-2, C2BBE1)	√	X	X		ATCC, [29]
Mouse	Neuroblastoma (N1E-115)	√	X	X		ATCC, USACEHR 2008 unpublished
Rat	Brain cortex (#R-CX-500)	√	X	X		Lonza, Curtis et al, 2009 unpublished
Mouse	Sertoli (15P-1)	X	√	X		ATCC, [31]
Human	Liver epithelial cells (Hep-G2)	X	X	X		ATCC, [29]
Human	Neuroblastoma (SH-SY5Y)	X	X	X		ATCC, Curtis 2009 unpublished
Cow	Brain microvessel endothelial (AC-2509)	X	X	X		Lonza, Curtis 2009 unpublished
Vertebrate Non-Mammalian						
Rainbow trout	Gill (RTgill-W1)	√	√	√	√	[5], [22]
Rainbow trout	Intestinal (RTgut-GC)	√	√	√	√	L. Lee/Wilfrid Laurier U, USACEHR unpublished
Rainbow trout	Liver (RTL-W1)	√	√	√	√	L. Lee/Wilfrid Laurier U, USACEHR unpublished
Gecko	Lung epithelial cells (GL-1)	√	√	√	√	ATCC, [31]
Iguana	Heart cells (IgH-2)	√	√	√	√	ATCC, [29, 31]
Walleye	Fin epithelial cells (WECF11-e)	√	√	√		N. Bols/U of Waterloo, [31]
Goldfish	Brain (GFB3C-W1)	√	√		√	L. Lee/Wilfrid Laurier U, USACEHR unpublished
Clawed Frog	melanophore	√	√	X	√	E. Lerner/Harvard U, [38]
Fathead minnow	Connective tissue/muscle epithelial cells (FHM)	√	√	√	X	ATCC, [31], USACEHR unpublished
Rainbow trout	Brain (RTbrain-W1)	√	√	√	X	L. Lee/Wilfrid Laurier U, USACEHR unpublished
American eel	Neuronal cells (EelB)	√	√	√	X	L. Lee/Wilfrid Laurier U, USACEHR unpublished
Walleye	Retinal epithelial cells (SAPRE)	√	√	√	X	N. Bols/U of Waterloo, Curtis 2012 unpublished
Mixed	EelB, RTgill	√	√	√	X	USACEHR unpublished
Walleye	Heart endothelial (WEBA11F)	√	√	X		N. Bols/U of Waterloo, Curtis 2012 unpublished
Walleye	Skin fibroblast (WESK11)	√	√	X		N. Bols/U of Waterloo, Curtis 2012 unpublished
Mixed	EelB, melanophore	√	√		X	USACEHR unpublished
Mixed	RTgill, melanophore	√	√		X	USACEHR unpublished
Box turtle	Heart cells (TH-1)	√	X			ATCC, [31]
Topminnow	Hepatoma (PLHC-1)	X				ATCC, Curtis 2011 unpublished
Leopard	Epithelial cells (ICR134)	X				ATCC, [31]
Invertebrate						
Mosquito	Larval cells (Sua1B)	X	X			J. Bloomquist/U of Florida, [31]
Fall armyworm	Sf-9	X	X			ATCC, [31]
Fruit fly	Schneider 2 (S2)	X	X			Life Technologies, [31]
Tobacco	Pupal ovary cells (HvAM1)	X	X			C. Goodman/USDA, [31]
Fall armyworm	Ovary (IPLB-HvT1)				X	Dwight Lynn, USDA 2007 unpublished
Multiple	19 cell lines: 1 Coleoptera, 1 Diptera, 15 Lepidoptera, 2 Hymenoptera				X	Dwight Lynn, USDA 2007 unpublished
Parasitic wasp	Embryo (DM2)				X	Dwight Lynn, USDA 2007 unpublished

^a Formation of stable monolayer in this report is defined as less than a 20% reduction in impedance values over the two-week storage time.

^b Field sustainability is defined as less than 20 percent reduction in impedance values when cells are stored for a minimum of 3 months in the enclosed fluidic biochip with no medium replenishment.

^c Initial Toxicity screening is defined as a preliminary chemical screening of the cell line on the ECIS sensor. Suitability would be considered acceptable if the cell line detects a certain number of chemicals in less than one hour when combined with the ACE test results leads to the detection of >50 percent of the test chemicals detected between the MEG and HLC. Exceptions would include the insect cell lines evaluated at USDA 2007 where cytotoxicity was evaluated by morphological response endpoint and Resazurin fluorescence.

Table 3. Field suitability of cell lines for use in the ECIS system

Four cell lines were selected as potential candidates for a field-deployable ECIS sensor in initial open-well testing by Curtis et al. [29], but only the gecko lung epithelial cells, GL-1, (ATCC, Manassas, VA) were non-mammalian and could be considered for field use since they do not require exogenous CO₂ or a temperature of 37 degrees Celsius for viability. Although Table 3 indicates that both the GL-1 cells and the iguana heart cells, IgH-2, (ATCC, Manassas, VA) could be suitable for use in a fieldable ECIS system, there were temperature restrictions on these cell lines when held in a 90-day period on fluidic biochips that eliminated them from further consideration. IgH-2 cells had stable impedance readings only when stored at 20 degrees Celsius, but when the cells were stored at either 6 degrees Celsius or 37 degrees Celsius, the cells impedance levels dropped rapidly. The GL-1 cells had stable impedance readings when stored at 25 degrees Celsius, but when the cells were stored at either 6 degrees or 36 degrees Celsius, there was also a loss of stable impedance readings [31]. The RTgill-W1 cell lines, however, proved to be superior in meeting all of the field suitability requirements outlined in Table 3.

It is important to note that rainbow trout cell liver and intestinal cell lines, as well as fathead minnow connective tissue/muscle epithelial cells, were also tested on the fluidic biochips (see Table 3, unpublished data) and also showed promise for use in an ECIS fieldable biosensor. At the time, these cell lines were not an improvement over the RTgill-W1 cells. Therefore, the RTgill-W1 cells were selected for further advancement with the ESB.

3.2 Omics Evaluations for ECIS Biomarker Identification

Analyzed metabolomics, proteomics, and transcriptomics results are not yet available at the time of the writing. As illustrated in Figure 6, however, preliminary metabolomic data using MALDI-FT-ICR imaging/profiling collected from RTgill-W1 cells on ECIS biochips directly exposed to copper at a concentration of 47 mg/L for one hour resulted in a dramatic drop in levels of citrate, adenosine monophosphate, and adenosine diphosphate.

3.3 ESB/ECIS Field Testing

The AMEDD Board assessment found a high false positive rate for the ECIS test. Further investigations were initiated to determine the cause of the false responses, since no false positive responses occurred during prior EPA testing. Results yielded a false positive rate similar to the prior Army Medical Department Board assessment. Based on these findings, it was determined that the false positives were not due to procedural error but rather reflect the inherent variability of the test system under field use by preventive medicine personnel.

The statistical models were adjusted to incorporate the variability noted under these field conditions and validated to ensure that no significant loss in toxicant sensitivity occurred due to the sensitivity adjustments. During the AMEDD Board assessment, the ACE™ sensor test results were found to be acceptable; no further refinements or modifications to the test system were required.

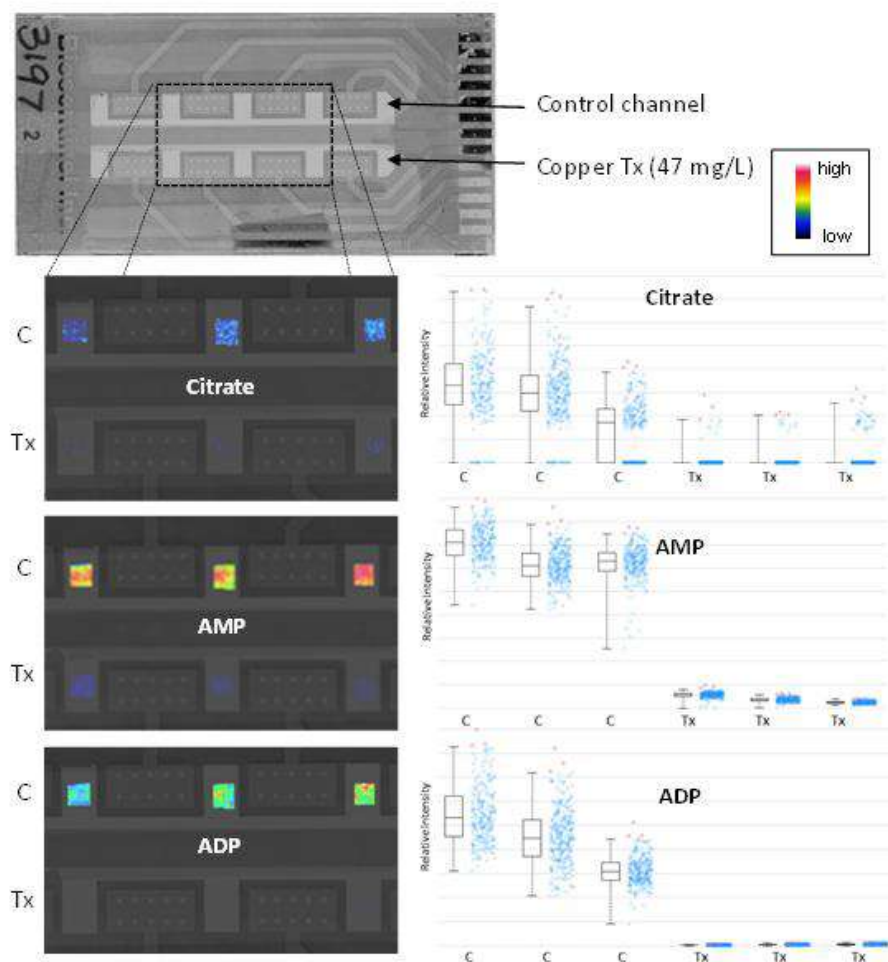

Figure 6. Metabolomic interrogation of copper exposed RTgill-W1 cells directly from ESIS device using MALDI-FTICR imaging/profiling. (Left panel) Top- Image of the ESIS device after spray coating with 9AA matrix and mounted onto a MALDI target for FTICR profiling. Exploded view) three areas of the RTgill-W1 cellular monolayer growing on the control or copper exposed fluidic chamber were interrogated in the instrument and the metabolites citrate, adenosine monophosphate (AMP) and adenosine diphosphate (ADP) were detected. Relative intensity levels of these metabolites (using the color scale provided top right) were dramatically reduced in cells exposed to 47mg/L of copper for 1 hour. (Right panel) Box-plots of discriminate analysis for metabolite differences found in control versus treatment cells. Each box-plot contains a rectangle divided by a horizontal line, which represents the median intensity of that metabolite. Lower and upper bounds of the box represent the second and third quartile. Lines extending vertically from the box represent lower and upper quartiles (0% and 99% respectively). The cloud part of the plot shows how spectra from a given region are spread by intensity for each metabolite and region. Blue dots represent the spectra in-which intensities are between the lower and upper quartiles. Red dots represent outliers.

As discussed above, additional ECIS control field performance testing was performed at the 1st AML to evaluate the false positive rate of the ECIS sensor. A total of two false positives out of 36 control samples resulted from this supplemental testing. Observation of the testing as it was conducted revealed no procedural errors that could be linked to the false positives. The statistical algorithm used in the ECIS sensor was then evaluated. The algorithm used to detect toxic water samples was a curve discrimination program that used a control model based on an accumulated set of prior control responses [29].

An analysis of the data in comparison to previously collected test periods was performed in an effort to understand the sources of variability and, if possible, model the variability to eliminate the false detections. Results from this modeling effort are shown in Table 4, which include control testing performed at USACEHR, the 1st AML, Battelle Labs as part of EPA TTEP testing, and the AMEDD Board customer assessment. The first column of data shows the control results using the originally developed statistical model described in Curtis et al. [29]. Results from two additional statistical models applied to the various control tests are shown in the following columns. One control model included all available control test data (161 control tests), and another model included all data except the Army preventive medicine personnel-generated data so that preventive medicine data could be used to test the model as an independent test set. Different α -levels were also evaluated in an attempt to optimize the false positive rate to near zero without significantly reducing toxicant sensitivity.

Arsenic test replicates from the EPA TTEP testing had the lowest magnitude of toxicant response of all toxicants tested that provided a positive test response within the MEG-HLC range, which provided a good opportunity to optimize the false positive rate against the likelihood of generating a false negative and/or reducing the number compounds detected within range by the sensor. Models that maintained 4/4 positive test responses with arsenic while having no false positives in Army testing were considered advantageous. The 125 control chip model with $\alpha=0.0005$ proved to be optimal and was used for the test evaluation at AFMESA by the 1st AML. Results for the 1st AML AFMESA testing yielded neither false positive nor false negative results. The supplemental figures in Appendix A show examples of the ECIS graphics of false positive results for control chips for USACEHR, the 1st AML, and the AMMEDD Test Board Customer Assessment used in optimizing the statistical models.

	TRL6NoPreExposure.cfg (22 control files)	AdvancedDevNoPreExposure_125.cfg (125 control files)			AdvancedDevNoPreExposure_161.cfg (161 control files)		
	$\alpha=0.001$ Original Statistical Model	$\alpha=0.001$	$\alpha=0.0005$ New Statistical Model	$\alpha=0.0004$	$\alpha=0.001$	$\alpha=0.0005$	$\alpha=0.0004$
USACEHR (76 control tests)	2 false positives	2 false positives	1 false positive	0 false positives	2 false positives	1 false positive	1 false positive
1st AML March 2015 (36 control tests)	2 false positives	0 false positives	0 false positives	0 false positives	0 false positives	0 false positives	0 false positives
EPA TTEP 2014 (49 control tests)	0 false positives	0 false positives	0 false positives	0 false positives	0 false positives	0 false positives	0 false positives
Total False Positive Tests (161 Control Tests)	4	2	1	0	2	1	1
EPA TTEP Chemical Detection (Arsenic 4 of 4)	4/4	4/4	4/4	3/4	4/4	4/4	4/4
2014 AMEDD Test Board CA (26 control tests)	4 false positives	1 false positive	0 false positives	0 false positives	2 false positives	0 false positives	0 false positives

Table 4. Statistical Modeling Results - Control Tests

3.3.1 Environmental Testing

The ECIS and ACE™ tests passed environmental testing [36]. One notable exception was the operational ACE™ test conducted at low temperature, where the negative control tickets failed to show viable enzyme activity at the 15 minute reading. This was likely due to lower enzyme activity at the lower test temperatures, as the test reading was successful when the 15 minute incubation time was extended to 25 minutes. In one case, the ECIS chip had an initially low impedance reading so a second chip was used. Weak response to the positive control (sodium chloride) suggested that selection of a different chemical for a positive control may be appropriate.

3.3.2 Field Testing

Results of the AMEDD Board were supportive of ESB field use and can be summarized as follows [37]:

- The functionality of the ESB system supports the preventive medicine mission. Test completion time met CDD requirements, and 11 of 13 assessment participants indicated that ESB functionality was mission supportive.
- The ESB system was usable in an operational environment. System weight met CDD requirements, and the ESB functioned under 120 VAC, 220VAC, and internal battery power, as required. All 13 assessment participants reported that the ESB was usable for water sample analysis in an operational environment.
- The ESB does not pose any actual or potential safety hazards to personnel, equipment, or facilities in an operational environment. The pliers used to open the ACE™ reagent vials pose a minor cut hazard.
- The ESB system was usable after transport. The ESB was successfully used to conduct water sample analyses after a transportation test. Figure 7 shows soldiers using the ESB during the customer assessment in a field laboratory setting as well as in the back of a high mobility multipurpose wheeled vehicle after transport on an off-road course.



Figure 7. Soldiers performing water testing with the ESB device

In spite of the generally positive assessment, several instances of false positive and negative readings were encountered with the ECIS. The false negatives occurred with the ammonia positive control, likely due to the ammonia concentration being set at too low a level. The false positives (four out of 26 samples tested) were more problematic and were thought to be related to the sensitivity setting used for the system statistical software. Subsequent field

evaluations of the ESB focused on ECIS and the relative occurrence of false positive and negative samples. As noted above, the positive control test chemical was changed from ammonia to either arsenic or pentachlorophenate. Choosing a higher concentration of ammonia was not considered, as it causes a pH color change in the test media; soldiers would recognize there was a difference in these samples from regular control samples (thus introducing user bias). As described above, subsequent test and statistical modeling evaluations led to the development of improved statistical algorithms, which were evaluated with the AMEDD Test Board data and effectively eliminated the false positive responses that were generated during the testing (see Table 4).

3.3.3 In-theater Evaluations

Overall, the in-theater evaluations of the ESB system were highly favorable. There were no issues shipping equipment and reagents into theater (five days from Fort Detrick, MD, to Camp Taji, Iraq), and ECIS biochips remained viable and were maintained by the theater biochemist for all of the evaluations by preventative medicine personnel. ECIS tests were completed in 19 of 20 evaluated with only one test yielding an error; there were no false positives. The cause of the test failure could not be determined. All 20 evaluators stated that the ESB system was supportive of the preventative medicine mission. Theater biochemists on different tours also transported the ESB system with them on missions to Camp Taji and missions to Northern Iraq, where successful water testing was performed.

4. Implications and Future Directions

4.1 Cell Line Selection

A number of toxicity sensors for water using a range of cell types have been proposed; however, challenges still exist in identifying sensors that both have appropriate sensitivity to toxicants and favorable long-term stability, making the sensor suitable for real-world applications. Invertebrate cells were screened because they can be maintained at different temperatures, can grow on simplistic media, and do not require exogenously supplied CO₂. Unfortunately, the tested invertebrate cells did not form tight junctions, which precluded these cells from reaching impedance values over 1,000 ohms, making them unsuitable for ECIS testing.

Testing with mammalian cell lines indicated that endothelial and epithelial cells had the best storage capabilities because these cells were contact inhibited and ceased to divide once a monolayer had formed. These cell types also formed extensive cell-cell junctions, yielding high impedances [39]. There were some exceptions to these overall observations. For example, the human intestinal epithelial cells initially displayed impedances over 1,000 ohms, but over a two-week storage period, the impedances decreased to 800-900 ohms, which correlated with an increase in the formation of fluid-filled domes. These domes form when Caco-2 cells are grown on non-porous surfaces; it is postulated that the domes result from the transport of fluid across the cell layer [40] and may be responsible for decreased impedance over time.

Hepatocyte cell lines were screened because of their superior toxicant responses. Unfortunately, when hepatocytes are grown on a solid substrate and not in a flexible collagen gel, the cells de-differentiate, losing their liver-specific

characteristics [41]. We found that hepatocytes seeded on the ECIS electrodes did not maintain their epithelial characteristics and tended to overgrow, becoming clumpy and leading to long-term storage problems.

The major obstacles to using mammalian cells in a portable cell-based biosensor were the requirements for strict temperature regulation, periodic feeding, and exogenously supplied CO₂. The only mammalian cell type that did not have strict temperature requirements was the Sertoli cell line (15P-1) isolated from the testis of mice. Although the Sertoli cells could be stored at different temperatures, at room temperature the impedance of this cell layer became unstable. This instability may be due to a relatively high cellular metabolism rate, possibly leading to rapid depletion of media components and generation of waste products in the enclosed fluidic biochip environment, resulting in a decrease in cell health. One major challenge with using mammalian cells as toxicity sensors is the inability to maintain cell viability under field conditions for extended periods of times. A portable cell maintenance system was developed to support mammalian cell health on the ECIS sensors in field conditions, but the system had limitations including high cost, large size, and consumables that were sufficient for only nine days of storage time [30]. Even though some mammalian cells may have promising toxicity response characteristics, they were more difficult to maintain, which hampered the development of field-usable, cell-based toxicity sensors [42-44].

The cell group that showed the most promise in the development of a field-portable, commercially viable, cell-based biosensor was the non-mammalian vertebrate cells. Mammals (and birds) are endothermic animals, defined as having a stable body temperature regardless of the environmental temperature. Non-mammalian vertebrates, such as reptiles, amphibians, and fish, are ectothermic animals, defined as having a fluctuating body temperature influenced by the environmental temperature. Because an organism's core temperature is directly related to its metabolic rate, at low environmental temperatures, the ectothermic animal has very little energy requirements and maintains a hypometabolic state. The relationship between metabolism and temperature in ectothermic cell lines makes this cell group an ideal candidate for field portable sensors. The hypometabolic state allows the cells to survive in an enclosed biochip environment with no medium replenishment for long periods of time, which decreases both the use of media components and the generation of waste products that can negatively impact cell health. The cells can easily be stored at refrigerated temperatures in this hypometabolic state, and the biochips can then be removed from refrigerated storage when they are required for toxicant testing.

It was determined that each ectothermic cell line has specific temperature requirements to facilitate long-term storage in an enclosed biochip. To keep cells stable in the enclosed fluidic biochip, the storage temperature needs to be at the low end of the organism's range. For example, geckos have a temperature tolerance of 18.2-35.6 degrees Celsius [45]. When a cell line isolated from this organism (GL-1) was stored in the fluidic biochip, it only survived long-term at 20 degrees Celsius, but not at 25 or 36 degrees Celsius. Rainbow trout have a temperature tolerance of 4–25 degrees Celsius [46], so cell lines from rainbow trout (RTgutGC, RTL-W1, and RTgill-W1) have been shown to survive for nine months or more on the fluidic biochip at 6 degrees Celsius with no media replenishment [5]. These data support the hypothesis that different cells from the

same organism (in this case the rainbow trout) have storage temperatures that are similar (and in alignment with) the whole organism's core temperature. This type of corollary information may help facilitate the selection of cell lines for specific testing platforms and environments. Currently, the rainbow trout gill epithelial cells (RTgill-W1) are the preferred cell line in the ESB system due to long-term refrigerated storage (6 degrees Celsius) capabilities and chemical toxicant detection [5]. Exploration of other candidate cell lines may provide more flexibility in the field for the ECIS-based toxicity sensor. If 6 degrees Celsius storage is not available, then cell lines with different optimal storage temperatures could be used and tailored for the testing environment.

While the rainbow trout gill epithelial cells (RTgill-W1) are currently the preferred cell line for field use by the Army, there are limitations. Rainbow trout cell impedance levels begin to drop when the ambient temperature rises above 25 degrees Celsius, which is the upper desirable temperature range of the whole organism. While the ECIS sensor maintains temperature during testing, this temperature tolerance limitation may affect the utility of this cell-based sensor in some field environments where chip storage temperature control cannot be maintained. Other non-mammalian vertebrate cell lines with a wider temperature tolerance may add value to sensing capabilities in different field conditions. Zebrafish, for example, have a thermal tolerance range of 6.7-41.7 degrees Celsius [47], and multiple cell lines exist from this organism to potentially serve in a cell-based sensor. Another noteworthy temperature tolerant fish is the sheepshead minnow, which lives in extreme tidal pool habitats where the temperature can range from 1.9 to 43 degrees Celsius [48]. Interestingly, cells derived from this fish may also be able to survive sudden temperature fluctuations because it has adapted to live in tidal pools, which are rapidly changing environments. Future work will explore these cells to determine if they have superior qualities over the RTgill-W1 cell line.

The ECIS test, in its current configuration, has limitations in detecting acetylcholinesterase-inhibiting insecticides in the chemical panel (specifically, organophosphate and carbamate chemicals). The inclusion of a neuronal cell in the ECIS test could allow detection of these pesticides and simplify the ESB system. We have experimented with mammalian neuroblastoma cells in the ECIS system because they were easy to grow and have neuroblast-like characteristics. Continuous cell division, however, eliminated neuroblasts as an option since long-term storage of these cells was not feasible. We have also experimented with primary neuronal cells from both mammalian and non-mammalian origins, but implementation in a commercially viable system would be difficult because of their lack of cell division. An approach for the future may be to use neuroblast-like cells from a non-mammalian vertebrate because the cells would have favorable cold storage characteristics, rapid population doubling times, and may be able to be chemically treated with retinoic acid to induce differentiation into mature neurons [49]. This would allow biochips to be easily seeded with the rapidly growing neuroblasts and then stored for long-term with the non-dividing mature neurons.

Another obstacle to overcome with using neuronal cells in the ECIS test is the inability of the cells to effectively cover the electrode surface to yield a high enough impedance to ensure test sensitivity. Possibilities for remediating this may be co-

culturing the neurons with glial cells, which are the supportive cells that surround the neurons in the central nervous system. Co-culturing would simulate a more *in vivo*-like environment for the neurons, potentially increasing impedance levels for use in the ECIS system. Impedance technology does exist to measure cell shape changes of individual cells on a substrate [50], so that subtle changes in the neuron shape, such as axon retraction, may be measured following toxicant exposure.

In recent years, *in vitro* cell models have become more complex in an effort to create a more realistic model of the environment inside the whole organism. Organ- or body-on-a-chip devices can mimic *in vivo* conditions, such as fluid-to-cell ratios, shear stress, and fluid residence times, creating a more holistic environment for chemical exposures. Also, these multi-cell and/or multi-compartment systems allow metabolism-induced cytotoxicity to be evaluated, making these platforms a powerful tool for toxicity testing [51, 52]. For example, orally ingested chemicals in drinking water would pass through the intestinal wall and then go through the liver before entering the bloodstream. Understanding how these cellular compartments biotransform the chemicals will be very important in systemic toxicity predictions.

A multi-compartment gastrointestinal tract-on-a-chip accurately metabolized a model chemical and accurately predicted toxicity to the metabolites—as would happen inside the human body [53]. Single cell systems currently used for toxicity evaluations do not have the ability to biotransform orally ingested drugs, so the *in vitro* toxicity measured often does not correlate with what would happen *in vivo*. But while the more complex organ- and body-on-a-chip platforms may have greater predictive power for toxicity evaluations, such platforms are impractical for field applications in the foreseeable future given their maintenance requirements and the short-lived viability of the mammalian cells used in them.

In an effort to make systems that more accurately predict toxicity but are still field deployable, a few key areas need to be explored. To date, all organ- and body-on-a-chip advancements have been made using mammalian (mainly human) cells to address the need for creating more robust cellular models for drug discovery and testing. Building organ- or body-on-a-chip devices with non-mammalian vertebrate cells with wider temperature tolerance ranges could allow for more accurate models to be constructed that could potentially tolerate cold storage, limiting cell maintenance requirements and extending survival times. Fish or amphibians on-a-chip could serve as an environmental monitoring model for a wide range of toxicants found in drinking water.

In addition to the difficulty in maintaining vertebrate cells in the field, another significant obstacle to the fielding of more complex cellular systems is the lack of label-free, noninvasive, real-time methods to assess cell viability. Cellular impedance via ECIS technology has been shown to be a sensitive indicator of cell viability and cytotoxicity [54–56], and we have used it as the sensing technology in the ESB system. Additional label-free endpoints have been suggested. For example, adding dissolved oxygen and pH endpoints to ECIS can provide toxicity-related changes in cellular oxygen consumption and extracellular acidification as indicators of cellular metabolism [57–59]. The trade-off is whether any additional toxicant sensitivity provided would justify possible increases in test complexity and cost and reductions in the overall utility of the test in the field.

Improvements in ECIS monitoring itself could also be considered; many studies suggest that monitoring cells in a 3D conformation can provide better toxicity response information than using traditional 2D cultures [51, 52]. ECIS works by measuring changes in cell-cell adhesion, cell-matrix adhesion, or membrane capacitance on a population of cells that are adherent to a flat gold electrode. The configuration of the current system makes it hard to integrate into a 3D organ system, but some recent advances may allow this beneficial end-point to be used in more complex systems. Hepatocytes, important cells in toxicity sensing, need to be cultured in a soft biocompatible substrate (hydrogel) as a 3D microtissue-termed spheroid and not as a cell layer adherent to a solid substrate. When grown in this preferred conformation, the cells are stable and keep their liver-specific characteristics for at least five weeks [60].

Advances in impedance sensing platforms and hydrogel formulations may allow the viability of cells in complex configurations to be assessed. ECIS has been used to examine impedance of cell layers covered with hydrogel [61], but the cell layers are still adherent to the flat sensing electrode, creating the bulk of the electrical resistance. Future optimization of impedance sensing technologies may allow the viability of true 3D microtissues embedded in hydrogel that are not directly adherent to the sensing electrodes. Biocompatible hydrogels have been mixed with conducting polymers to create a gel that supports three dimensional growth of cells with a very low electrical resistance [62]. These systems may be sensitive enough to allow the resistance of the live cellular membranes to be differentiated from membranes disrupted from toxicants. Cell impedance sensing technology exists that can detect and discriminate live cells from dead cells in a fluid droplet [63] or single cells migrating through gel [63], so technology exists to use impedance sensing for smaller and more complex sensing platforms. These all electric approaches may enable more complicated 3D cellular systems to become field deployable.

4.2 Omics Evaluations for ECIS Biomarker Identification: Toxicity Pathway Improvement of ECIS

The ECIS component of the ESB System using the RTgill-W1 cell line can detect at or near human lethal concentrations of many toxic chemicals in water. While this is a first in real-time, in-theater broad spectrum toxicity monitoring for drinking water, a positive response still requires reach back to the in-theater biochemist and/or to CONUS support for chemical analysis and identification of the actual toxic entities. Continuing to improve on the real-time specificity of toxicant identification is an important area for future research and development. Additionally, chemical concentrations for health-based guidelines are often much lower than current ECIS detection limits and may require more sensitive methods of testing. It is hoped that the information generated from metabolomic, proteomic, and transcriptomic exposures will provide further evidence of cellular responses that can be directly correlated with human toxicity.

Success of the methods will be measured by the number of chemicals with identified “omics”-based toxicity testing endpoints and their relationship to unhealthy exposure levels for humans as represented in the MEG estimates. If omics techniques are able to identify key toxic responses, it may be possible to assay them within the current ECIS sensor for real-time field detection; even if it is

necessary to perform the assays at an offsite location, it would be possible to identify improved patterns of soldier exposures to and health risks from environmental toxicants. Ultimately, the goal is to provide improved, robust toxicity detection in resource-limited environments to avoid soldier exposure to toxic or contaminated water supplies.

4.3 ESB/ECIS Field Testing

The development of the ESB was approved in 2009 as a program of record for the Army due to the need for preventive medicine personnel to have the capability to screen potable water for the presence or absence of TICs [14]. As the ESB evolved into the dual toxicity sensor that is in the pipeline for field deployment, customer assessment by Army preventive medicine personnel and field testing provided critical feedback that could not be obtained in a laboratory setting. This customer feedback led to modifications in some of the practical aspects of the ESB, such as manipulating pipets and syringes, accurately measuring water samples, ease of opening vials, and clarification of instructional materials.

The feedback also allowed for fine-tuning of statistical algorithms to ensure that false negatives and positives would be a rare occurrence. Knowing that the ESB was well received in these field situations by the targeted users encouraged the USACEHR scientific staff to improve upon the current sensor by exploring the possibility of adding biomarkers to the RTgill-W1 cell sensor to increase toxicant sensitivity via omics exploratory investigations. As the ESB continues to evolve beyond its current capability, we will continue to seek field testing for new modifications so that it remains a useful tool to provide safe drinking water for the Soldier and other branches of the armed forces.

5. Conclusion

The development of the ECIS test as part of the ESB system illustrates how a cell-based sensor can be deployed in support of DoD needs to detect a wide range of chemicals that may contaminate water, food, or air. Because cell-based systems can respond to a variety of toxic modes of action, they can be especially useful in identifying threats associated with novel, unknown, or unsuspected materials or chemical mixtures. As such, the ECIS/ESB system should be a useful addition to the WQAS-PM used by Army preventive medicine personnel for field drinking water testing when it is fielded in FY19.

Efforts to improve the sensitivity, specificity, and predictive value of the ECIS device have included evaluations of more than 50 cell lines. Non-mammalian vertebrate cells best met Army requirements for toxicant sensitivity and suitability for field use, and as a result of the cell line screening effort, rainbow trout gill epithelial cells (RTgill-W1) were selected for use in the ECIS device. To maximize toxicity-relevant information obtained from these cells, we are seeking molecular indicators/biomarkers of toxicity via metabolomic, proteomic, and transcriptomic interrogation. Although results from this effort are not yet available, it is hoped this research will lead to identification of key indicators of toxicity pathways that will in turn improve the sensitivity and specificity of the ECIS test. To further improve the ECIS/ESB system, we will continue to employ customer feedback received from Army preventive medicine personnel in field tests to make operational improvements.

Over the next five to 10 years, cell-based systems better able to predict human health effects may involve an organ- or body-on-a-chip approach. Although mammalian cells are now commonly used in such systems, using non-mammalian vertebrate cells that have lower maintenance requirements, better temperature range tolerance, and longer-term viability may offer the best potential for a device that could be used under field conditions. Although the technical challenges are significant, a fieldable body-on-a-chip device would allow more rapid, reliable assessments of toxicity and, combined with suitable biomarkers, provide useful information on warfighter chemical exposures and health outcomes.

References

1. Eltzov, E., & Marks, R. S. (2011). Whole-cell aquatic biosensors. *Analytical and Bioanalytical Chemistry*, 400(4), 895-913. doi: 10.1007/s00216-010-4084-y
2. Pancrazio, J. J., Whelan, J. P., Borkholder, D. A., Ma, W., & Stenger, D. A. (1999). Development and application of cell-based biosensors. *Annals of Biomedical Engineering*, 27(6), 697-711. doi: 10.1114/1.225
3. States, S., Scheuring, M., Kuchta, J., Newberry, J., & Casson, L. (2003). Utility-based analytical methods to ensure public water supply security. *Journal - American Water Works Association*, 95(4), 103-115. doi:10.1002/j.1551-8833.2003.tb10337.x
4. Kelly, T., Baxter, W., McCauley, M., & E. Koglin. (2008). *Testing of screening technologies for detection of toxic industrial chemicals in all hazards receipt facilities* (Technology Evaluation Report EPA/600/R-08/034). Washington, DC. Retrieved from <https://nepis.epa.gov/Exe/ZyPURL.cgi?Dockkey=P1001AB9.txt>
5. Brennan, L. M., Widder, M. W., Lee, L. E., & van der Schalie, W. H. (2012). Long-term storage and impedance-based water toxicity testing capabilities of fluidic biochips seeded with RTgill-W1 cells. *Toxicology in vitro*, 26(5), 736-745. doi: 10.1016/j.tiv.2012.03.010
6. van der Schalie, W. H., Shedd, T. R., Knechtges, P. L., & Widder, M. W. (2001). Using higher organisms in biological early warning systems for real-time toxicity detection. *Biosensors and Bioelectronics*, 16(7-8), 457-465. doi: 10.1016/S0956-5663(01)00160-9
7. Kramer, K. J. (2009). Continuous monitoring of waters by biological early warning systems. *Rapid Chemical and Biological Techniques for Water Monitoring Water Quality Measurements*, 197-219. doi: 10.1002/9780470745427.ch3e
8. Banerjee, P., Kintzios, S., & Prabhakarandian, B. (2013). Biotxin detection using cell-based sensors. *Toxins*, 5(12), 2366-2383. doi: 10.3390/toxins5122366
9. Tan, L., & Schirmer, K. (2017). Cell culture-based biosensing techniques for detecting toxicity in water. *Current Opinion in Biotechnology*, 45, 59-68. doi: 10.1016/j.copbio.2016.11.026
10. Brennan, L. M., Widder, M. W., McAleer, M. K., Mayo, M. W., Greis, A. P., & van der Schalie, W. H. (2016). Preparation and testing of impedance-based fluidic biochips with RTgill-W1 cells for rapid evaluation of drinking water samples for toxicity. *Journal of Visualized Experiments*, 109. doi:10.3791/53555
11. Cevenini, L., Calabretta, M. M., Tarantino, G., Michelini, E., & Roda, A. (2016). Smartphone-interfaced 3D printed toxicity biosensor integrating bioluminescent "sentinel cells". *Sensors and Actuators B: Chemical*, 225, 249-257. doi: 10.1016/j.snb.2015.11.017
12. Headquarters, Departments of the Army, Navy and Air Force. (2010). *Sanitary control and surveillance of field water supplies* (TB MED 577/ NAVMED P-5010-10/ AFMAN 48-138_IP). Washington, DC. Retrieved from <https://www.med.navy.mil/directives/Pub/5010-10.pdf>
13. Salem, H., Whalley, C. E., Wick, C. H., Gargan, T. P., & Burrows, W. D. (2008). Chemical warfare agent threat to drinking water. In *Chemical*

- warfare agents: *Chemistry, pharmacology, toxicology, and therapeutics* (2nd ed., pp. 21-50). Boca Raton, FL, CRC Press.
14. U.S. Army. (2013). Capability Development Document for Environmental Sentinel Biomonitor Increment: 1. Catalog of Approved Requirement Documents (CARDS #14099). (Unpublished manuscript, available from the Office of the U.S. Army Deputy Chief of Staff, G-8, 700 Army Pentagon, Room 3E406, Washington, DC 20310-0700)
 15. U.S. Environmental Protection Agency. (2008). Quality Management Plan 2008 (QMP). Homeland Security Technology Testing and Evaluation Program. Columbus, OH: Battelle.
 16. U.S. Army Public Health Command. (2013). *Environmental health risk assessment and chemical exposure guidelines for deployed military personnel* (Technical Guide 230). Aberdeen Proving Ground, MD: U.S. Army Public Health Command. Retrieved from <https://phc.amedd.army.mil/PHC%20Resource%20Library/TG230-DeploymentEHRA-and-MEGs-2013-Revision.pdf>
 17. Toxicology for Excellence in Risk Assessment (TERA). (2006). Derivation of human lethal doses (USACEHR TR-0802). Fort Detrick, MD: U.S. Army Center for Environmental Health Research. Retrieved from <http://www.dtic.mil/dtic/tr/fulltext/u2/a494706.pdf>
 18. Kooistra, S., & Walther, J. (2013). *Environmental Sentinel Biomonitor technology assessment* (ECBC-TR-1074). Aberdeen Proving Ground, MD: Edgewood Chemical Biological Center, U.S. Army Research, Development, and Engineering Command. Retrieved from <http://www.dtic.mil/dtic/tr/fulltext/u2/a586335.pdf>
 19. van der Schalie, W. H., James, R. R., & Gargan II, T. P. (2006). Selection of a battery of rapid toxicity sensors for drinking water evaluation. *Biosensors and Bioelectronics*, 22(1), 18-27. doi: 10.1016/j.bios.2005.11.019
 20. Trader, D. E., & van der Schalie, W. H. (2010). *An evaluation of the eclox chemiluminescence test, hach pesticide/nerve agent test strips, and agri-screen test tickets* (USACEHR Technical Rep. 1002). U.S. Army Center for Environmental Health Research: Fort Detrick, MD. Retrieved from <http://www.dtic.mil/dtic/tr/fulltext/u2/a525515.pdf>
 21. Lee, L. E. J., Dayeh, V. R., Schirmer, K., & Bols, N. C. (2009). Applications and potential uses of fish gill cell lines: Examples with RTgill-W1. *In Vitro Cellular & Developmental Biology-Animal*, 45(3-4), 127-134. doi: 10.1007/s11626-008-9173-2
 22. Widder, M. W., Brennan, L. M., Hanft, E. A., Schrock, M. E., James, R. R., & Schalie, W. H. (2015). Evaluation and refinement of a field-portable drinking water toxicity sensor utilizing electric cell-substrate impedance sensing and a fluidic biochip. *Journal of Applied Toxicology*, 35(7), 701-708. doi: 10.1002/jat.3017
 23. Trader, D. E., & van der Schalie, W. H. (2014). *An evaluation of the NIDS® ACE™ Test* (USACEHR Technical Rep. 14-01). U.S. Army Center for Environmental Health Research: Fort Detrick, MD. Retrieved from <http://www.dtic.mil/dtic/tr/fulltext/u2/a603987.pdf>
 24. Duarte, I. F., Marques, J., Ladeirinha, A. F., Rocha, C., Lamego, I., Calheiros, R., ... & Gil, A. M. (2009). Analytical approaches toward successful human cell metabolome studies by NMR spectroscopy. *Analytical Chemistry*, 81(12), 5023-5032. doi: 10.1021/ac900545q

25. Emwas, A. H. M. (2015). The strengths and weaknesses of NMR spectroscopy and mass spectrometry with particular focus on metabolomics research. *Metabonomics: Methods and Protocols*, 161-193. doi: 10.1007/978-1-4939-2377-9_13
26. García-Cañaveras, J. C., Castell, J. V., Donato, M. T., & Lahoz, A. (2016). A metabolomics cell-based approach for anticipating and investigating drug-induced liver injury. *Scientific Reports*, 6, 27239. doi: 10.1038/srep27239
27. Dekker, T. J., Jones, E. A., Corver, W. E., van Zeijl, R. J., Deelder, A. M., Tollenaar, R. A., ... & McDonnell, L. A. (2015). Towards imaging metabolic pathways in tissues. *Analytical and Bioanalytical Chemistry*, 407(8), 2167-2176. doi: 10.1007/s0021
28. Cornett, D. S., Frappier, S. L., & Caprioli, R. M. (2008). MALDI-FTICR imaging mass spectrometry of drugs and metabolites in tissue. *Analytical Chemistry*, 80(14), 5648-5653. doi: 10.1021/ac800617s
29. Curtis, T. M., Tabb, J., Romeo, L., Schwager, S. J., Widder, M. W., & van der Schalie, W. H. (2009). Improved cell sensitivity and longevity in a rapid impedance-based toxicity sensor. *Journal of Applied Toxicology*, 29(5), 374-380. doi: 10.1002/jat.1421
30. Curtis, T. M., Widder, M. W., Brennan, L. M., Schwager, S. J., van der Schalie, W. H., Fey, J., & Salazar, N. (2009). A portable cell-based impedance sensor for toxicity testing of drinking water. *Lab on a Chip*, 9(15), 2176-2183. doi: 10.1039/B901314H
31. Curtis, T. M., Collins, A. M., Gerlach, B. D., Brennan, L. M., Widder, M. W., Van der Schalie, W. H., ... & Bols, N. C. (2013). Suitability of invertebrate and vertebrate cells in a portable impedance-based toxicity sensor: Temperature mediated impacts on long-term survival. *Toxicology in Vitro*, 27(7), 2061-2066. doi: 10.1616/j.tiv.2013.07.007
32. Buck, A., Ly, A., Balluff, B., Sun, N., Gorzolka, K., Feuchtinger, A., Janssen, K. P., Kuppen, P. J., van de Velde, C. J., Weirich, G. & Erlmeier, F. (2015). High-resolution MALDI-FT-ICR MS imaging for the analysis of metabolites from formalin-fixed, paraffin-embedded clinical tissue samples. *The Journal of Pathology*, 237(1), 123-132. doi: 10.1002/path.4560
33. Guijas, C., Montenegro-Burke, J. R., Domingo-Almenara, X., Palermo, A., Warth, B., Hermann, G., ... & Wolan, D. W. (2018). METLIN: A technology platform for identifying knowns and unknowns. *Analytical Chemistry*, 90(5), 3156-3164. doi: 10.1021/acs.analchem.7b04424.
34. Thompson, A., Schäfer, J., Kuhn, K., Kienle, S., Schwarz, J., Schmidt, G., ... & Hamon, C. (2003). Tandem mass tags: A novel quantification strategy for comparative analysis of complex protein mixtures by MS/MS. *Analytical Chemistry*, 75(8), 1895-1904. doi: 10.1021/ac0262560
35. Department of Defense. (2008). *Department of Defense test method standard: Environmental engineering considerations and laboratory tests (MIL-STD-810G)*. Retrieved from <https://www.atec.army.mil/publications/Mil-Std-810G/Mil-Std-810G.pdf>
36. U.S. Army Medical Research & Materiel Command. (2014). *Environmental Testing: Environmental Sentinel Biomonitor System, Test File #220*. (Unpublished manuscript, available from the U.S. Army Medical Research and Materiel Command, Test Branch, Schreider Street, Fort Detrick, MD 21702-5000).

37. Cabigon, G., & Breckheimer, D. (2014). Customer assessment report for the Environmental Sentinel Biomonitor (USAMEDDBD Project 3-12a). (Unpublished manuscript, available from the U.S. Army Medical Department Center and School, 3630 Stanley Road, Suite 301, JBSA Fort Sam Houston, TX 78234).
38. Iuga, A., Lerner, E., Shedd, T. R., & Van der Schalie, W. H. (2009). Rapid responses of a melanophore cell line to chemical contaminants in water. *Journal of Applied Toxicology*, 29(4), 346-349. doi: 10.1002/jat.1416
39. Benson, K., Cramer, S., & Galla, H.-J. (2013). Impedance-based cell monitoring: Barrier properties and beyond. *Fluids and Barriers of the CNS*, 10(1), 5. doi:10.1186/2045-8118-10-5
40. Lopez-Vancell, R., Beaty, G., Stefani, E., Rodriguez-Boulan, E. E., & Cereijido, M. (1984). Changes in paracellular and cellular ionic permeabilities of monolayers of MDCK cells infected with influenza or vesicular stomatitis viruses. *The Journal of Membrane Biology*, 81(3), 171-180. doi: 10.1007/BF01868711
41. Godoy, P., Hengstler, J. G., Ilkavets, I., Meyer, C., Bachmann, A., Müller, A., ... & Dooley, S. (2009). Extracellular matrix modulates sensitivity of hepatocytes to fibroblastoid dedifferentiation and transforming growth factor β -induced apoptosis. *Hepatology*, 49(6), 2031-2043. doi: 10.1002/hep.22880
42. DeBusschere, B. D., & Kovacs, G. T. (2001). Portable cell-based biosensor system using integrated CMOS cell-cartridges. *Biosensors and Bioelectronics*, 16(7-8), 543-556. doi: 10.1016/S0956-5663(01)00168-3
43. Pancrazio, J. J., Gray, S. A., Shubin, Y. S., Kulagina, N., Cuttino, D. S., Shaffer, K. M., ... & O'Shaughnessy, T. J. (2003). A portable microelectrode array recording system incorporating cultured neuronal networks for neurotoxin detection. *Biosensors and Bioelectronics*, 18(11), 1339-1347. doi: 10.1016/S0956-5663(03)00092-7
44. Pancrazio, J. J., Kulagina, N. V., Shaffer, K. M., Gray, S. A., & O'Shaughnessy, T. J. (2004). Sensitivity of the neuronal network biosensor to environmental threats. *Journal of Toxicology and Environmental Health, Part A*, 67(8-10), 809-818. doi: 10.1080/15287390490428279
45. Lawrence, C. (2007). The husbandry of zebrafish (*Danio rerio*): A review. *Aquaculture*, 269(1-4), 1-20. doi: 10.1016/j.aquaculture.2007.04.077
46. Dayeh, V. R., Lynn, D. H., & Bols, N. C. (2005). Cytotoxicity of metals common in mining effluent to rainbow trout cell lines and to the ciliated protozoan, *Tetrahymena thermophila*. *Toxicology in vitro*, 19(3), 399-410. doi: 10.1016/j.tiv.2004.12.001
47. Stokes, D., & Meek, R. (2003). Diurnal body temperatures in semi-captive Tokay Geckos (*Gekko gekko*); Evidence for thermoregulation? *Herpetological Bulletin*, 85, 23-27.
48. Bennett, W. A., & Beitinger, T. L. (1997). Temperature tolerance of the sheepshead minnow, *Cyprinodon variegatus*. *Copeia*, 1997(1), 77-87. doi: 10.2307/1447842
49. Cheung, Y. T., Lau, W. K. W., Yu, M. S., Lai, C. S. W., Yeung, S. C., So, K. F., & Chang, R. C. C. (2009). Effects of all-trans-retinoic acid on human SH-SY5Y neuroblastoma as in vitro model in neurotoxicity research. *Neurotoxicology*, 30(1), 127-135. doi: 10.1016/j.neuro.2008.11.001

50. Asphahani, F., Wang, K., Thein, M., Veiseh, O., Yung, S., Xu, J., & Zhang, M. (2011). Single-cell bioelectrical impedance platform for monitoring cellular response to drug treatment. *Physical Biology*, 8(1), 015006. doi: 10.1088/1478-3975/8/1/015006
51. Esch, M. B., King, T. L., & Shuler, M. L. (2011). The role of body-on-a-chip devices in drug and toxicity studies. *Annual Review of Biomedical Engineering*, 13(1), 55-72. doi: 10.1146/annurev-bioeng-071910-124629
52. Esch, E. W., Bahinski, A., & Huh, D. (2015). Organs-on-chips at the frontiers of drug discovery. *Nature Reviews Drug Discovery*, 14(4), 248. doi: 10.1038/nrd4539
53. Mahler, G. J., Esch, M. B., Glahn, R. P., & Shuler, M. L. (2009). Characterization of a gastrointestinal tract microscale cell culture analog used to predict drug toxicity. *Biotechnology and Bioengineering*, 104(1), 193-205. doi: 10.1002/bit.22366
54. Giaever, I., & Keese, C. R. (1993). A morphological biosensor for mammalian cells. *Nature*, 366(6455), 591-592. doi: 10.1038/366591a0
55. Keese, C. R., Karra, N., Dillon, B., Goldberg, A. M., & Giaever, I. (1998). Cell-substratum interactions as a predictor of cytotoxicity. *In Vitro and Molecular Toxicology: Journal of Basic and Applied Research*, 11(2), 183-92.
56. Ceriotti, L., Ponti, J., Broggi, F., Kob, A., Drechsler, S., Thedinga, E., ... & Rossi, F. (2007). Real-time assessment of cytotoxicity by impedance measurement on a 96-well plate. *Sensors and Actuators B: Chemical*, 123(2), 769-778. doi: 10.1016/j.snb.2006.10.024
57. Thedinga, E., Kob, A., Holst, H., Keuer, A., Drechsler, S., Niendorf, R., ... & Ehret, R. (2007). Online monitoring of cell metabolism for studying pharmacodynamic effects. *Toxicology and Applied Pharmacology*, 220(1), 33-44. doi: 10.1016/j.taap.2006.12.027
58. Kubisch, R., Bohrn, U., Fleischer, M., & Stütz, E. (2012). Cell-based sensor system using l6 cells for broad band continuous pollutant monitoring in aquatic environments. *Sensors*, 12(3), 3370-3393. doi: 10.3390/s120303370
59. Guijarro, C., Fuchs, K., Bohrn, U., Stütz, E., & Wölfl, S. (2015). Simultaneous detection of multiple bioactive pollutants using a multiparametric biochip for water quality monitoring. *Biosensors and Bioelectronics*, 72, 71-79. doi: 10.1016/j.bios.2015.04.092
60. Bell, C. C., Hendriks, D. F., Moro, S. M., Ellis, E., Walsh, J., Renblom, A., Puigvert, L.F., Dankers, A.C., Jacobs, F., Snoeys, J. & Sison-Young, R. L. (2016). Characterization of primary human hepatocyte spheroids as a model system for drug-induced liver injury, liver function and disease. *Scientific Reports*, 6, 25187. doi: 10.1038/srep25187
61. Tran, T. B., Cho, S., & Min, J. (2013). Hydrogel-based diffusion chip with Electric Cell-substrate Impedance Sensing (ECIS) integration for cell viability assay and drug toxicity screening. *Biosensors and Bioelectronics*, 50, 453-459. doi: 10.1016/j.bios.2013.07.019
62. Ding, H., Zhong, M., Kim, Y. J., Pholpabu, P., Balasubramanian, A., Hui, C. M., ... & Bettinger, C. J. (2014). Biologically derived soft conducting hydrogels using heparin-doped polymer networks. *ACS Nano*, 8(5), 4348-4357. doi: 10.1021/nn406019m

63. Kemna, E. W., Segerink, L. I., Wolbers, F., Vermes, I., & van den Berg, A. (2013). Label-free, high-throughput, electrical detection of cells in droplets. *The Analyst*, 138(16), 4585-4592. doi: 10.1039/c3an00569k
64. Nguyen, T. A., Yin, T. I., Reyes, D., & Urban, G. A. (2013). Microfluidic chip with integrated electrical cell-impedance sensing for monitoring single cancer cell migration in three-dimensional matrixes. *Analytical Chemistry*, 85(22), 11068-11076. doi: 10.1021/ac402761s

Appendix A: False Positive Outliers (see Table 4)

ECIS Statistical Analysis Results

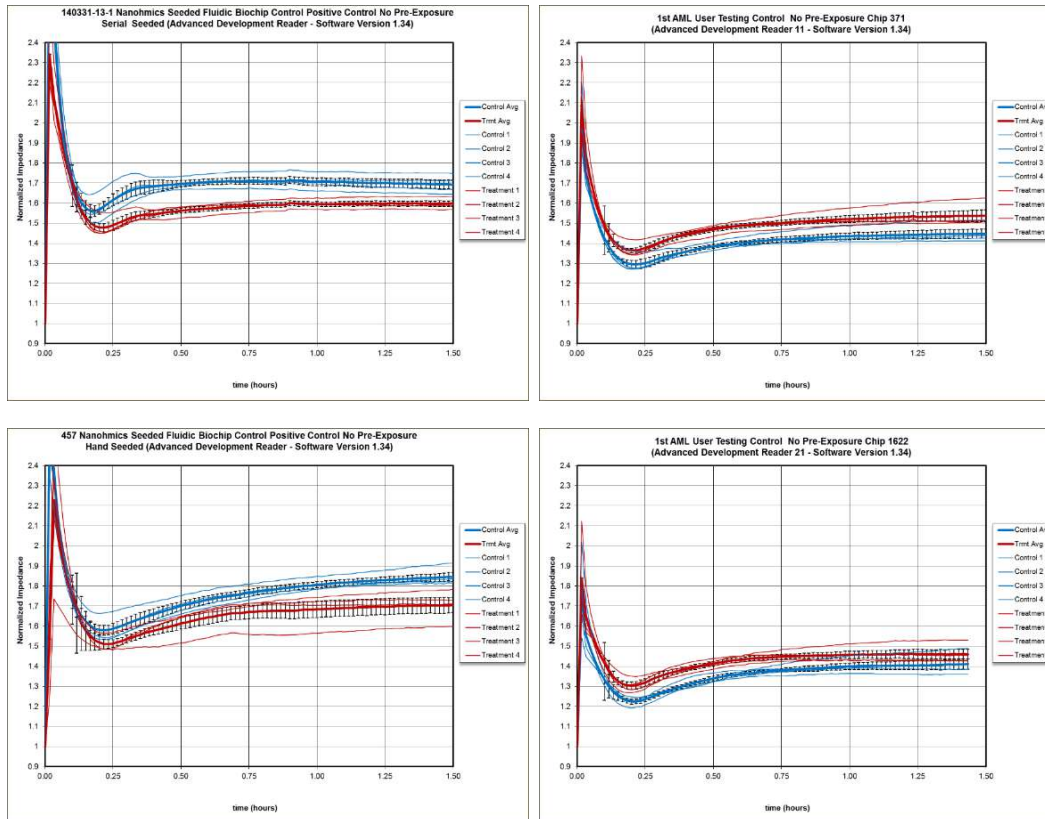

False positive control outliers (USACEHR and 1st AML)

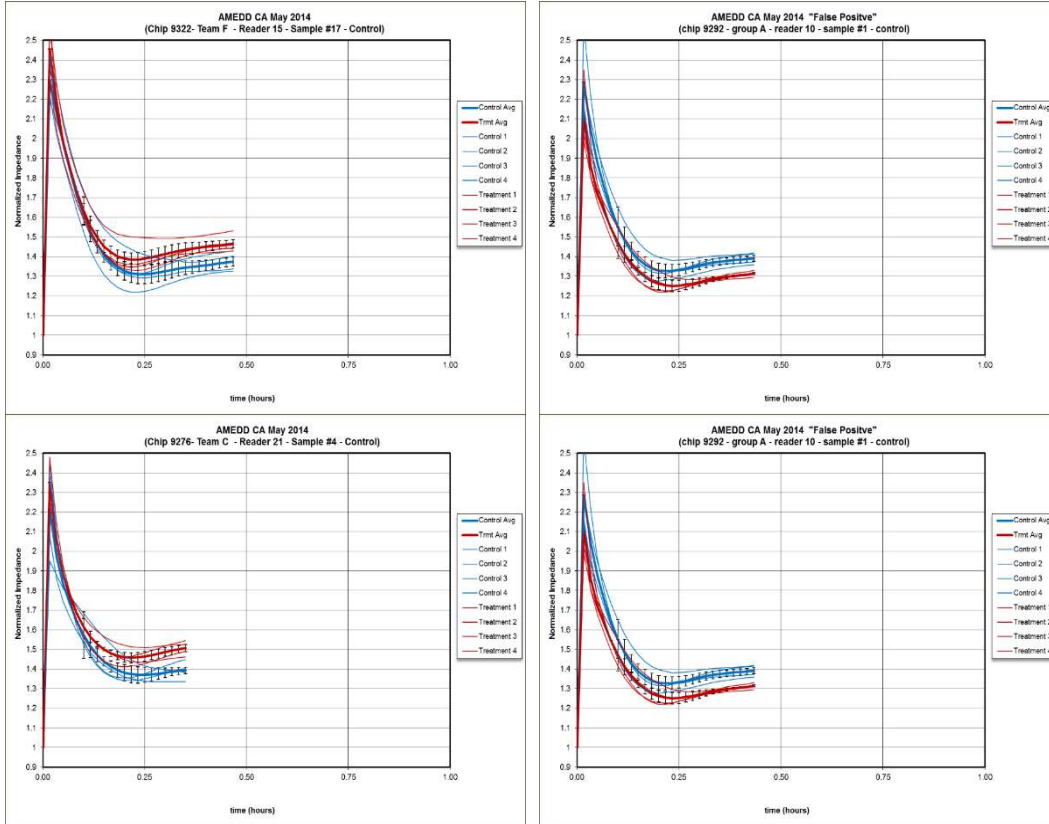

False positive control outliers (AMEDD Test Board)

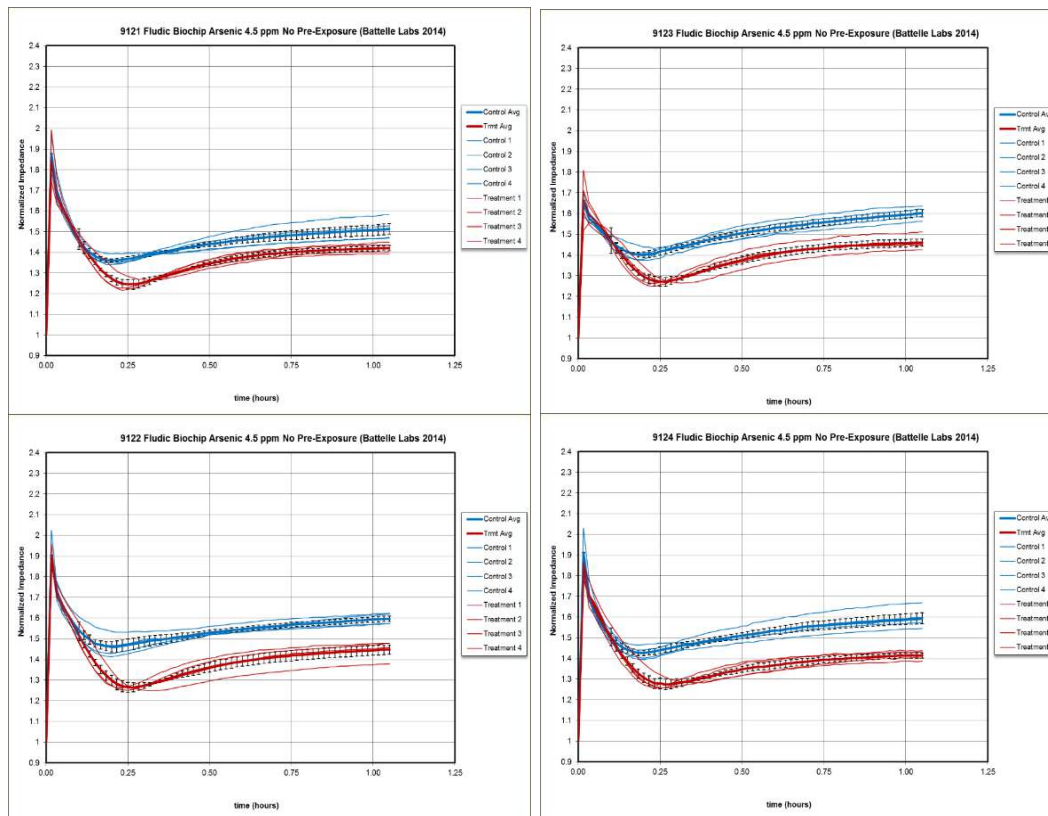

True positives – EPA TTEP Arsenic (at HLC)

Acknowledgements:

The authors would like to thank the Massachusetts Institute of Technology Lincoln Laboratory, especially Fran Nargi and Chelsea Peragallo, for their work on the development of transcriptomic sample preparation for the RTgill-W1 cells. We would also like to thank Dr. Lucy Lee (University of Fraser) for being our RTgill-W1 cell culture mentor and acknowledge Dr. Niels Bols (Waterloo University) for the development of the RTgill-W1 cell line. Also, additional thanks to Nanohmics, Inc. and ANP Technologies for their commercial support in developing the ESB system. A final thank you to all the U.S. Army medical personnel (military, civilian, and contractors) who have helped to develop and advance the ESB system.

Disclaimer:

The views, opinions, and/or findings contained in this report are those of the authors and should not be construed as official Department of the Army position, policy, or decision, unless so designated by other official documentation. Citations of commercial organizations or trade names in this report do not constitute an official Department of the Army endorsement or approval of the products or services of these organizations. This research was supported in part by an appointment to the Research Participation Program at the U.S. Army Center for Environmental Health Research administered by the Oak Ridge Institute for Science Education through an interagency agreement between the U.S. Department of Energy and USAMRMC.

4

Inventory and Supply Chain Management Technologies for Situational Awareness

Trisha Miller, Sandia National Laboratories
Sean DeRosa, Sandia National Laboratories

1. Introduction

This SOAR discusses a range of methods for investigating the use of chemical and biological weapons of mass destruction (WMD). Detection technologies, including sensors, diagnostics, and sampling methods, aid in the investigation of WMD use both prior to and after a chemical or biological release. In addition, methods and tools that track legitimate-use agents, precursors, equipment, and resources that could be misappropriated to develop chemical and/or biological weapons are another key component of investigations into WMD use. These technologies, along with traditional detection methods and threat intelligence, provide situational awareness that drives prevention and supports response, recovery, and event reconstruction activities. This section reviews methods and tools currently used to track chemical and biological assets that enable situational awareness.

1.1 What is Situational Awareness?

A 1998 National Research Council report defines situational awareness as “the perception of the elements in the environment within a volume of time and space, the comprehension of their meaning, and the projection of their status in the near future [1].” This definition can be adapted to the context of investigating chemical and biological WMD as follows:

Situational awareness is the observation of chemical and biological assets in the world around us (e.g., moving through the supply chain and being used for legitimate purposes), the comprehension of normal versus anomalous activity, and the evaluation of these activities for potential indicators of threat.

In other words, situational awareness is gained by collecting information on legitimate uses of chemical and biological assets from a wide array of sources and integrating this information into a bigger picture to gain a global understanding of how high-risk assets are being used—and potentially misused. For example, thiodiglycol is a precursor in the synthesis of mustard gas. However, it is also a solvent and commonly used in water-based inks and dyes and is therefore prevalent in research labs and industry (textiles, paints, pulp, and paper processing, etc.) [2]. Situational awareness for mustard gas threat activity is formed by gathering data on the manufacture and use of thiodiglycol across industries (along with that of other relevant precursors) to identify normal versus abnormal activity.

Innovations in chemistry and biology shape our modern world, from pharmaceuticals and clean water, to food and agriculture, energy, and household

goods. The tangible benefits of the chemical and biological sciences are undeniable, yet these advancements are not achieved without bearing some risk of their misuse. Recent headlines remind us that chemical and biological threats remain a concern [3–5], and studies show that new technologies can directly enable nefarious activities [6–8]. A few examples of these technologies include chemical micro process devices, gene editing technologies, and aerosol delivery systems. Balancing the security risks against the advantages of scientific advancements requires increasing barriers for misappropriation while minimizing barriers for innovation. Situational awareness of chemical and biological assets plays an important role in meeting this objective.

1.2 Situational Awareness in a Detection Architecture

Methods and tools for situational awareness, although inherently different from other detection technologies reviewed in this report, are an important part of an effective chemical and biological detection architecture. This architecture can be thought of in terms of a timeline where different detection capabilities enable different phases of WMD security. Prior to an incident (“left of boom”), detection of threat activity may enable prevention or interdiction. After an incident (“right of boom”), agent detection may enable early warning, rescue, diagnosis and treatment of exposed populations, attribution, and remediation (see Figure 1).



Prevent	Interdict	Warn	Rescue	Diagnose/Treat	Attribute	Remediate
Surveillance			Equipment/Sensors		Forensic Detection	Environmental Sampling
Situational Awareness		Satellite	Medical Diagnostics			

Figure 1. Timeline for WMD security. The yellow burst, often referred to as a “boom,” represents the point at which a chemical or biological WMD incident occurs.

Within a detection architecture, situational awareness methods and tools are primarily used to support prevention and interdiction activities. Before an incident, situational awareness methods and tools seek to:

- Collect data about what/where chemicals and biological assets are being used,
- Integrate that data into a bigger picture of normal activities, and
- Enable the identification of atypical activity that may warrant further investigation

A combination of data analytics would likely be used to support these tasks. Supply chain management and inventory systems enable data collection on the movement and use of assets over time. This data would be used to build an end-to-end view of asset activity. Analytics can then be applied to develop insights into asset activity: for example, seasonal trends, localization of assets, and patterns of use. Analytical tools often include graphical, geospatial, and/or temporal visualizations to further explore the data. Private industries use a variety of supply chain data analytics for business and operational management (e.g., demand forecasting,

supplier performance). However, data analytics for situational awareness would integrate data across multiple supply chains to monitor activities of chemical and biological assets associated with WMD.

After an incident (right of boom), situational awareness data collected and analyzed before the incident can play a key role in investigating an attack and tracing the material back to responsible parties (see Figure 1). For example, after the 2001 Anthrax Letters attack, forensic analysis of the spores linked the material to *Bacillus anthracis* inventories at the U.S. Army Medical Research Institute of Infectious Disease (USAMRIID) [9]. In other words, situational awareness data on anthrax assets at USAMRIID enabled investigators to identify the source and attribute the attack. Just as on-scene agent detection is used to respond to and later inform diagnosis and treatment, situational awareness data can be leveraged in other phases of the end-to-end detection architecture.

This section of the SOAR discusses state-of-the-art methods and tools for situational awareness and their role in investigating WMD use. We propose a framework for discussing technologies for situational awareness and use the framework to review methods and tools currently used to track chemical and biological agents, precursors, equipment, and resources. We also discuss gaps and challenges that hinder situational awareness and explore the future state of WMD situational awareness, including an evaluation of relevant technologies and data in other realms that could be applied to investigation of WMD use.

2. Framework for Discussing Situational Awareness Technologies

Chemical and biological sciences play a prominent role in our society and economy. As a result, there is a significant presence of agents, precursors, equipment, and other resources distributed across laboratories, facilities, and supply chains that could be misappropriated. There are many systems in place to track the use and movement of chemical and biological assets for business, environmental, or safety purposes. Situational awareness technologies leverage or extend these more general tracking capabilities to specifically manage security risk.

A framework is proposed for discussing situational awareness capabilities. Along one axis of the framework, chemical and biological assets are divided into two categories:

- **Agents and precursors** – Includes chemical or biological materials, such as reagents, catalysts, plasmids, vectors, and other materials that are required for the weaponization of an agent
- **Equipment and resources** – Includes assets that enable manipulation and storage of agents and precursors, as well as resources for protection and safe handling

Along the other axis, the tracking location of chemical and biological assets are divided into two categories:

- **Node-level location** – Includes laboratories and facilities where assets are made, used, stored, or distributed (Typically, an inventory of assets is maintained at the node-level.)
- **System-level location** – Includes the movement of assets through supply chains (Typically, chemical and biological assets may be registered in a tracking system at start and end points.)

Combining these two axes into the framework shown in Figure 2 allows us to evaluate how situational awareness technologies in each of the four categories may be used to achieve different security goals.

		Asset Types	
		Agents/Precursors	Equipment/Resources
Location Tracking	Laboratories/ Facilities (node)	Agents/Precursors + Laboratories/Facilities (node)	Equipment/Resources + Laboratories/Facilities (node)
	Supply Chains (system)	Agents/Precursors + Supply Chains (system)	Equipment/Resources + Supply Chains (system)

Figure 2. Framework for discussing situational awareness capabilities

Due to the extensive dual use of chemical and biological assets, a risk-based approach is typically applied to prioritize the protection of assets of greatest concern. Although approaches for risk assessment vary, the high-level security scenarios of concern include theft, diversion, sabotage, and direct attack. Technologies for situational awareness seek to prevent and interdict these types of attacks. The risk level for these types of scenarios varies across the framework depending on the type of asset and location. Accordingly, classes of situational awareness technologies that mitigate the risks also vary across the four categories defined in the framework. For example, inventory management and access controls systems may be most effective at detecting a theft from a laboratory, thereby foiling a plot in preparation. Customer databases and analytics may be more effective technologies for preventing bad actors from acquiring assets.

Risk management strategies also differ across this framework for chemical versus biological scenarios. The U.S. government has identified the Chemical Sector as one of the 16 critical infrastructure sectors—an important contributor to the U.S. economy [10]. Therefore, large-scale situational awareness technologies are needed at the system level to track high-risk assets/precursors. One of the biggest challenges for biosecurity is managing emerging equipment/resources that enable sophisticated capabilities in small laboratories. For example, toolkits that enable genome editing (e.g., CRISPR technologies) are increasingly available and easier

to use [11, 12]. Therefore, node-level situational awareness technologies for equipment/resources may be more impactful for biological assets.

3. Current State of Situational Awareness Technologies

Assets that pose a security risk (i.e., chemical and biological materials, equipment, or resources that may be maliciously used) require additional control and accountability measures throughout their lifecycle. High security risk assets are often identified and prioritized through risk assessments to maximize the resources applied to increase asset protections. A “high security risk” designation on chemical and biological materials, equipment, or resources is often promulgated by external entities such as treaties, policies, or regulatory programs. For example, the Chemical Weapons Convention (CWC) identifies agents and precursors at three different levels of risk based on past production, stockpile, or use as a chemical weapon, lethal or incapacitating toxicity, precursor status, production in large commercial quantities for purposes not prohibited under the CWC, and other criteria [13]. Similarly, the U.S. Department of Commerce identifies and regulates high-risk items through the Export Administration Regulations Commerce Control List. This list includes all items subject to “multi-lateral nonproliferation regimes to which the U.S. adheres” and other items for “national security, foreign policy, or short supply purposes [14].”

Beyond these programs, risk assessment methods can be used by individual organizations, facilities, and laboratories to identify, prioritize, and manage high-risk assets [15]. A security risk assessment differs from a safety risk assessment because it considers the intent and capability of a bad actor rather than focusing on the likelihood an accident. The benefit of laboratory-specific security risk assessments is that they reflect local threat considerations and are tailored to the organization. As the threat landscape changes, security risk assessments may also change over time. This potential for change in risk highlights the importance of ongoing risk assessments to feed an evolving risk management strategy.

3.1 Node-level Situational Awareness

Node-level situational awareness includes the tracking of assets within a research or industrial laboratory or at a manufacturing, storage, or distribution facility.

3.1.1 Agents/Precursors

Laboratory inventories of chemical and biological materials are maintained to improve efficiency of lab operations and guide safe practices. As a result, all materials used in the laboratory are usually recorded in an inventory system. The following characteristics are typically recorded in cradle-to-grave inventory systems: what, where, how much, associated risks (safety risks are most commonly identified), and material lifecycle (acquisition, use, transfer, and destruction).

Approaches for creating and maintaining an inventory have evolved significantly since the 1980s when inventories were kept on paper in three-ring binders. By the 1990s, inventories had shifted to electronic management on stand-alone systems. And by the 2010s, electronic inventories had transitioned to online or cloud-based systems, making distributed, enterprise management more feasible [16].

At the time of writing, the current standard for inventory management relies on barcode-based tracking of materials [17]. State-of-the-art inventory tools also enable connectivity to electronic notebooks and allow association of metadata, such as common methods and reagents, to facilitate the tracking of material usage [18]. A variety of software tools is available for inventory management, and technology features, such as passive or active tracking (e.g., with RFID tags), continuous or periodic updating, laboratory or enterprise-level systems, and different levels of cyber protections, may be selected to fit the operations of the facility.

There are two key steps in leveraging common inventory technologies for situational awareness: (a) identifying agents and precursors in the inventory that are high security risk, and (b) enabling processes for rapidly identifying and resolving inventory discrepancies.

As described above, the highest risk chemical weapon agents and precursors are identified in the CWC, which requires State Parties to establish a “verification regime” for these high-risk materials [13]. In 2017, the DoD Office of Inspector General recommended a “100-percent physical inventory of [Schedule 1] chemical agents, by primary container to establish a baseline [19].” Once the baseline is established, alternative inventory practices may be implemented. Best practices for effectively protecting and maintaining the inventory include operator training on reporting and resolving inventory discrepancies and segregating accountability duties across operators [19]. This indicates the importance of collecting data on “who” is accessing/using materials, in addition to “what”, for situational awareness analysis.

Access control systems and procedures are an integral component of inventory management for these types of high-risk materials. Within these systems, records of who accessed the materials and when can be leveraged for situational awareness. A recent whitepaper from UniKey Technologies, Inc. indicates that the shift toward IT-based business operations is driving the evolution of the Physical Access Control Systems (PACS) industry toward integration of new technologies [20]. PACS that leverage technologies such as cloud computing and the internet of things could empower efficient and automated situational awareness analysis of which personnel access high-risk materials. While material inventory information is the basis for situational awareness data analytics, material access and accountability data also play an important role in tracking the movement and use of chemical and biological materials. In particular, data on who is accessing materials plays into the second step of resolving inventory discrepancies.

Beyond known weapon agents and precursors, many other hazardous, dual-use materials in industrial and research laboratories may be identified, either internally or externally, as a high security risk (e.g., chlorine and other TICs). Note that risk assessment and inventory verification should also be applied to newly developed hazardous materials as well. Inventory systems and other situational awareness technologies enable security-focused inventory management of these dual-use materials. For example, security risk information can be associated with materials in inventory systems along with safety information. Some chemical databases, such as CAMEO Chemicals, include regulatory information from programs like the Chemical Facility Anti-Terrorism Standards (CFATS) to encourage users to comply

with reporting requirements [21]. Materials identified and tracked as high-risk assets routinely have assigned personnel who are accountable for material control. This material control and accountability throughout the lifecycle of the material may also be documented in inventory control systems, as these records are important for forensics and investigations.

The frequency and accuracy of inventory verification efforts is key to identifying potential threat activity. Many organizations perform a top-to-bottom physical inventory only on an annual or semiannual basis, whereas automated inventory systems (e.g., RFID-based systems) may provide immediate notification of a discrepancy—a worthwhile investment for high-risk assets. The U.S. Department of Energy's (DOE) Oak Ridge National Laboratory successfully deployed an enterprise-wide passive RFID-based inventory management system by Open Wave RFID [22]. This system, which replaced a barcode-based inventory system, significantly reduced the burden of inventory verification. However, identification/notification is only half the battle; timely investigation and adjudication of inventory discrepancies are essential components of situational awareness. If a discrepancy is identified, a clear process should be defined for reporting and resolving it.

3.1.2 Equipment/Resources

It is equally as important to maintain situational awareness of laboratory equipment and resources as it is for chemical and biological materials. At the node-level (within laboratories and facilities) property management systems may be used to track durable, multiuse equipment such as centrifuges, high-performance liquid chromatography systems, shakers, hoods, gloveboxes, incubators, distillation columns, and diagnostic and analytical tools. Because these items are often large, shared assets, theft is unlikely, and misuse within the laboratory poses the greatest risk. While usage information may not be tracked for assets like shakers, hoods, and incinerators, analytical tools and automated systems often retain user logs, data, and analyses from previous experiments. To leverage this information for situational awareness, a monitoring process could be added to these systems that would notify an end user of suspicious activity (e.g., a researcher accessing certain pieces of equipment only after hours, when the laboratory is empty of personnel). Beyond tracking use/misuse of laboratory equipment, a greater challenge is tracking the acquisition and disposal of laboratory equipment, discussed below (see Section 3.2).

Other types of resources used in research and industrial laboratories that could facilitate threat activity include items like personal protective equipment (PPE), disposable research kits, and scientific software. For example, the ST53™ mask is a self-contained breathing apparatus designed specifically for use in CBRN hazard environments. This type of specialized PPE is used by the military and first responders in live agent training and tactical operations [23]. Atypical procurement of this equipment could be an indicator of threat activity. Although there is a greater risk of theft associated with these items compared to laboratory equipment and resources, most are widely available for purchase online. Resources like novel technologies and information (plans, blueprints, data) may warrant additional security protections and situational awareness [24]. Loss or compromise of these resources should trigger additional investigation into potential threat activity.

The greatest challenge in achieving node-level situational awareness within facilities and laboratories is ensuring the accuracy and timeliness of inventory management. Risk-based approaches help address these challenges in part by identifying the scenario of concern (theft, diversion, misuse), prioritizing assets needing material control and accountability measures, and creating an appropriate response to inventory discrepancies. DoD has implemented the Comprehensive Inventory Management Plan, which was primarily driven by economic considerations to improve efficiency and reduce unnecessary storage of excess inventory [25, 26]. This inventory approach, when applied to transfers of industrial chemicals and gases, improves DoD's situational awareness of materials in its possession. While situational awareness at the node-level is beneficial on its own, system-level situational awareness integrates information across nodes and provides a more complete picture to inform security decision making.

3.2 System-level Situational Awareness

Material and equipment moving throughout markets create a complex network and supply chain. Situational awareness of such movement in this supply chain at the system-wide level can enable pre-incident interdiction and post-incident attribution.

Tracking asset movement data and end points may apprise analysts of anomalous purchases or combinations of purchases that may be suspicious (pre-incident). This type of tracking may be most useful for CWC Schedule 2 and 3 chemicals, unscheduled discrete organic chemicals, and other unscheduled TICs. These materials are used widely and in large quantities for industrial purposes, so individual purchases are not suspicious; however, patterns and norm deviations can be used to potentially warn of a change in use. Information gathered about movement of assets between suppliers and customers can be used to monitor customers or groups of customers that may be gathering materials/equipment that, on their own, are not concerning, but could present a proliferation risk when used together. After an incident, retracing the flow of materials can provide insight into methods used to acquire materials.

Several international systems, stemming from the CWC and Biological Weapons Convention, have been set up to restrict and track the flow of high risk materials and equipment [27]. The information collected for these programs, along with other relevant supply chain information, can be used to construct a systems-level view of chemical and biological supply chains.

A generic example of this systems-level view is a supply chain network made up of nodes that are connected by edges that represent asset purchases or shipments from one node to another. This type of network view can be constructed for both equipment and material trade. Organizing this data to provide a complete picture is a technical challenge because individual companies may have information about their own supply chain, but complete datasets about global movements of chemical and biological assets are not often produced (especially for equipment). There is an opportunity to fill in missing data in these networks using inference algorithms [28] based on information such as process stoichiometry, regional manufacturing output, and plant locations reported to the Organisation for the Prohibition of Chemical Weapons (OPCW).

Once the data is established to describe asset movements around the globe, it can be analyzed to provide situational awareness. The goal of such situational awareness is to provide an indication of the potential use of legitimate supply chains and purchases of TICs by state and non-state actors in patterns that may indicate an ability to construct chemical or biological WMD.

Triethyl phosphite provides an example of how supply chain data can be supplemented with additional information in order to establish situational awareness for WMD prevention. Categorized as a high production volume industrial use material but a precursor to nerve agents, it is a Schedule 3 chemical, which means it may be traded among States Parties to the CWC without prior approval. Triethyl phosphite is used to manufacture flame retardants, optical brighteners, pesticides, antioxidants, and pharmaceuticals [29]. Supply chain data can be used to construct a view of triethyl phosphite (or precursors in stoichiometrically relevant amounts) imports to a region. If a region is consistently importing triethyl phosphite, but manufacturing output data shows none of those categories of materials being produced, then the actual use of phosphorous trichloride should be investigated.

The situational awareness gained from monitoring supply chain data is best used to detect non-state actors and requires the full cooperation of all countries involved in the supply chain and transactions. National export controls are only effective at denying proliferator material acquisition when the entire international system is working together. The goal of the Australia Group is to coordinate export controls for a group of countries to ensure a unified approach among its member countries [30]. The main benefit of obtaining situational awareness is to gain insight into what is happening outside of the States Party to CWC or part of the Australia Group. The countries outside of these agreements do not report supply chain activities, making it easier for non-state actors to obscure their behavior from the country of operation—therefore, supply chain information is required to track their behavior. Even within a country, increased communication between different government agencies that have a role in monitoring supply chains and assessing risk must work together, such as the Departments of Commerce (export control authority) and State (to assist with tracking embargos and sanctions) [31]. From a technology standpoint, this coordination across agencies will require new methods and tools for data fusion and analysis.

3.2.1 System-level Information at Different Levels of Granularity

As in the node-level discussion (Section 3.1), system-level situational awareness methods and tools are discussed for agents/precursors and then for equipment/resources. But first, the granularity of data available for system-level situational awareness must be considered. Supply chain activity within domestic markets is regulated and tracked differently than movement between countries. The supply chain can be grouped into three levels, each providing different data granularity that can be used for situational awareness.

The first system level occurs entirely within a domestic market, where individual supply chains can be tracked by regulating transactions and establishing reporting procedures for certain materials and precursors. For example, the Ammonium Nitrate Security Program maintains records of registered ammonium nitrate sellers and purchasers, and requires vendors to keep records of sales for two years [32].

In 2017, a committee convened by the National Academies of Sciences, Engineering, and Medicine recommended a prioritized list of explosives precursors that should also be restricted [33]. With the anticipated inclusion of precursors into the regulation, a true end-to-end supply chain picture of ammonium nitrate will be possible. Still, visibility into domestic chemical supply chains remains a challenge because of the dynamic and complex nature of the market. Increasingly, digital solutions are being applied by companies to increase transparency and improve end-to-end planning [34]. While the primary goal in implementing these technologies is to boost profit and minimize waste, there is an opportunity (possibly for DHS) to leverage these real-time supply chain datasets for security-focused situational awareness. For example, DHS (through CFATS) currently manages the security risk of chemical materials at individual domestic plants (nodes), while the U.S. Coast Guard (through the Maritime Transportation Security Act [35]) regulates assets at ports, and the U.S. Department of Transportation regulates asset transport between locations. These three separate parts of the system make up different parts of the risk landscape. The merging of datasets hosted by multiple government agencies is a difficult organizational challenge, but if achieved, it could provide enhanced situational awareness of asset activity within the U.S. in real time.

The second system level involves aggregated information at the domestic level for reporting treaty compliance. The distinction here is that this information is not necessarily real time, since it is designed for annual reporting. Also, individual purchases and movement of materials around the country may not be included at this level, as reporting is usually focused on facility locations. Export and import data is aggregated at this national level, providing one component of the system-level picture. For CWC compliance, each state is required to establish or designate a clearly defined National Authority who gathers information and has ownership of the data analysis. For example, in the U.S., the Bureau of Industry and Security (BIS) is the lead agency responsible for compliance with the CWC. BIS aggregates industry declarations and reports to OPCW.

The third system level is international movement of materials and equipment. Internationally, the OPCW aggregates and reports each country's declarations and exports/imports of scheduled chemicals. Export requirements enable situational awareness to inform decision making in international markets. For example, BIS requires a license for certain materials, production equipment, analytical equipment, protective equipment, and technologies to be exported. The license requirement enables the tracking of end-users and leverages secondary government information sources that the seller may not have when BIS decides whether to approve or reject the license application [31]. The history of license approvals/denials is also considered when BIS makes a licensing decision [36]. Incorporating historical and current events occurring in the supply chain greatly enhances situational awareness during these licensing decisions. International supply chains of unscheduled chemicals are generally managed by private industry.

3.2.2 Supply Chain Data and Analytics

A significant amount of supply chain information is collected at different levels of granularity, and this data could be leveraged more broadly for improved chemical and biological situational awareness. For example, requiring customer registration

and licensing is a standard risk management approach used to restrict purchasers. Programs that require customer registration typically deal with specific anti-terrorism goals and are tied to specific chemicals and their precursors. Beyond risk management, the analysis of sales to registered users over time could be used to identify deviations in normal purchasing patterns. This type of data analytics could indicate potential suspicious behavior.

Data analytics of supply chain behavior can be applied in different ways. For example, Bauer et al. developed a methodology to infer relationships among entities using transfer entropy [37]. This approach could be applied to supply chains to help determine disparate entities that might be working together based on material and equipment acquisition patterns and magnitudes. Broader anomaly detection refers to identifying “patterns in data that do not conform to a well-defined notion of normal behavior [38].” Because large industrial plants may have purchasing and shipping patterns that are well defined and consumer purchases might be predictable, anomaly detection techniques would be able to identify purchasing/shipment patterns related to high-risk assets and differentiate this behavior from the normal network of asset movements around the globe. Research in big data applications for supply chain analytics is expanding, but this work usually focuses on an economic and efficiency perspective to improve performance and effectively manage logistics [39, 40]. There is an opportunity to apply these anomaly detection techniques originally developed for logistics to monitor supply chain behavior for security and risk management. For example, Camossi, Dimitrova, and Tsois present a security-focused framework for flagging irregular container shipments [41].

The following subsections describe the types of supply chain data collected, first for agents and precursors, then for equipment and resources that enable chemical and biological activity. The potential use of this data in supply chain analytics for situational awareness is also briefly discussed.

3.2.2.1 Agent/Precursor Supply Chains

Due to hazardous material regulations, much of the transportation, storage, and use of dual-use agents, chemicals, and precursors may be traceable. Security regulations often require that suppliers/vendors maintain records of sales of chemical and biological materials [21]. If an incident occurs, this data may be accessed and analyzed for post-incident event reconstruction and attribution. However, this node-to-node tracking data (i.e., movement of assets between supplier and customer) is not currently integrated for pre-incident, system-level situational awareness.

Information collected about the scheduled chemical supply chains for CWC compliance includes: declaration of new and existing facilities, past activities, exports and imports, and anticipated activities. Reporting requirements vary by schedule. Schedule 1 chemicals are the only assets that require advance notice to BIS, and then OPWC, before exporting [42]. A risk assessment of Schedule 2, Schedule 3, and unscheduled material supply chains could prioritize a subset of hazardous materials for additional data analytics to improve situational awareness efforts.

Separate from the verification part of OPCW's mission (typically geared toward inspections of facilities and stockpiles), the data on imports/exports can provide a picture of how dual-use materials (e.g., ammonium nitrate) are moving both within individual countries and internationally.

3.2.2.2 Equipment/Resource Supply Chains

Export controls are in place for equipment/resources just as there are export controls for agents/precursors. As with agents and precursors, export control data on equipment and resources could be analyzed for situational awareness on the movement of assets between countries. However, there is generally less visibility (i.e., minimal data collected) of supply chain movements within a country where export control regulations do not apply. In the U.S., less information is available to the government for security purposes regarding domestic supply chains of equipment than is available for agents/precursors. At this point, the supplies of common laboratory equipment (shakers, gloveboxes, analytical tools, etc.) may be too extensive and dispersed to achieve any meaningful situational awareness domestically [43]. Furthering the challenge, there is minimal oversight within the U.S. for disposal of laboratory equipment. Laboratories often sell, exchange, or donate equipment in unregulated markets (often online) when it is no longer needed. Dual-use equipment present in research laboratories poses a risk, as evidenced by the Islamic State's use of Mosul University chemistry laboratories for conventional and chemical weapon manufacturing [44, 45]. This example demonstrates the importance of situational awareness for equipment and resources in addition to agents/precursors.

4. Gaps and Challenges in Situational Awareness

In 2016, the OPCW released a summary of identified needs related to chemical safety and security management. Member states requested "inventory management systems, hazardous assessment tools, risk assessment tools," and chemical safety and security guidance documents and training [46]. These requested tools can work together to streamline data gathering and decision making, improving situational awareness of all high-risk chemical and biological assets within each country.

Supply chains are logistically complex and advanced analytics are increasingly used to improve the efficiency of operations. Opportunities exist to apply similar analytic techniques to manage supply chain security risks and gain insight into threat activity. Even though gathering and analyzing data to gain security situational awareness is technically (and potentially politically) challenging, the benefits of WMD situational awareness will far outweigh the challenges as data analytic methods and tools mature.

Improvement in overall situational awareness will require advances in three areas: a) clarifying *who* owns the system-level view (e.g., private industry stakeholders, federal agencies, international organizations) which depends on the regional scale of interest, b) identifying *what* assets are highest risk and are therefore a high priority for situational awareness, and c) advancing *how* data is gathered, integrated, and analyzed by adapting and developing data analytics technologies.

4.1 System-level Gaps and Challenges

The general systems-level situational awareness approach identifies the assets to track based on risk assessments, collects data at different geographic and temporal scales that match the risk strategy, and then enables national and international authorities to use this information to identify deviations from typical supply chain behavior that could be attributed to bad actors. An overarching challenge for systems-level situational awareness is determining which agencies have responsibility for integrating and analyzing different levels of data. Complicating factors include multiple levels of supply chain data, collection and use of proprietary data from private industries, and the jurisdiction of domestic agencies versus international groups.

With system-level data collection, each State Party to the CWC determines their own implementation approach, which may lead to differences in stringency between countries. U.N. Security Council resolution 1540 Matrix has worked to at least document the differences, enable the sharing of best-practices, and improve U.N. to State dialogue [47–49]. While reporting to the OPCW should be in the same form, the OPCW notes that technical discrepancies are sometimes found [50].

It is also challenging to implement user accountability at the systems-level. Accountability currently relies on user registries (such as ammonium nitrate in the U.S.), where suppliers verify legitimacy of users and then hand off responsibility with the transaction. Responsibility for monitoring user purchasing patterns and behavior falls to different agencies based on the type of material and how it's used.

4.2 Node-level Gaps and Challenges

At the node-level, the overarching challenge is collecting and maintaining accurate, actionable, and timely inventory data. In general, the process of creating material inventories is cumbersome and error-prone, and maintaining an inventory can be a tedious process—especially for frequently used items. These challenges are amplified for high security risk materials, where accuracy and timeliness are critical. Technologies that facilitate inventory verification and enable automated notification of discrepancies support improved situational awareness.

In addition, tracking inventory discrepancies across nodes is not currently handled. For example, if precursor A is missing in one lab, and precursor B is missing from a nearby lab, and $A+B = \text{weapon agent}$, there is no way to connect these two incidents. Technologies that integrate data across nodes would enable threat analysts to consider combinations of node-level activity that may constitute patterns of atypical activity. This also speaks to the challenge of integrating node-level data into a system-level analysis. Node-level data is, in a sense, a “fourth level” of supply chain data. However, while the other levels of supply chain data (defined in Section 3.2.1) track the movement of assets, inventory data focuses on asset usage. Therefore, while the key indicator for threat activity in supply chain analysis is behavioral changes, the key indicator for inventory analysis is record discrepancies. The holy grail of situational awareness technology would integrate near-real-time inventory and supply chain data with other relevant information (e.g., regional economic data, threat information, manufacturing and process data) to support end-to-end situational awareness.

5. Opportunities for Enhancing Situational Awareness

Chemical and biological materials are tracked and managed in many different domains for a wide variety of objectives. For example, the EPA collects chemical inventory data under the Risk Management Plan Rule to protect against accidental chemical releases [51]. As another example, the Drug Enforcement Agency collects data on the sales of drug precursors under the Chemical Control Program [52]. Chemical and biological security intersects with numerous domains (e.g., safety, economy and trade, environmental protection) where the distribution or use of chemical and biological materials is pertinent (see Figure 3). Because resources are often limited for developing new technologies specifically for chemical and biological security, there is an opportunity to leverage both data and tools utilized in other domains. Methods, tools, and technologies that enable efficient and accurate data collection, fusion, and analysis of the use and movement of chemical and biological assets, no matter their original application, can improve situational awareness.



Figure 3. Intersecting domains of technology

Furthermore, beyond data integration across chemical- and biological-relevant domains, there is an opportunity to better align risk management practices across domains such as chemical and biological safety and security. The OPCW stated that the objective of integrating chemical safety and security risk management is, “more effective risk management, better communication, increased safety and security culture, and more effective use of limited resources [46].” For example, restrictions in place for the Toxic Substance Control Act could be the basis for requirements on chemical imports and exports to improve dual-use security management. Numerous tools and methods were discussed in Section 3 that could be used to advance situational awareness of chemical and biological assets. Insights gained from situational awareness pays dividends beyond chemical and

biological security by improving the safety and efficiency of how those assets are moved and used.

Combining node-level and system-level information about equipment, resources, agents, and precursors can provide a holistic view of domestic and global movements of dual-use chemical and biological assets. Understanding not only what exists at individual facilities (node level), but also which countries or actors are acquiring which materials and when (system level) will enable both pre-incident interdiction and post-incident attribution. Tracking materials and equipment at nodes can alert to theft or misuse in a localized area, and tracking that same information across supply chains can identify anomalous behavior by actors throughout the system. Insight into node and system level activity, along with traditional detection methods and threat intelligence, can provide situational awareness that drives prevention and supports response, recovery, and event reconstruction activities.

References

1. Pew, R. W., & Mavor, A. S. (Eds.). (1998). Modeling human and organizational behavior: Application to military simulations. Washington, DC: National Academy Press. Retrieved from <https://www.nap.edu/read/6173/chapter/1>
2. National Center for Biotechnology Information, PubChem Compound Database. (n.d.). Thiodiglycol. Retrieved from <https://pubchem.ncbi.nlm.nih.gov/compound/thiodiglycol>
3. Berman, M. (2018, February 12). Trump Jr. says his wife is 'safe and unharmed' after opening letter containing unknown substance. *The Washington Post*. Retrieved from https://www.washingtonpost.com/news/post-nation/wp/2018/02/12/police-say-trump-jr-s-wife-taken-to-hospital-after-receiving-letter-with-unidentified-substance/?noredirect=on&utm_term=.108b21774644
4. Adam, K. (2018, March 7). Ex-Russian spy and his daughter were poisoned with a nerve agent, British police say. *The Washington Post*. Retrieved from https://www.washingtonpost.com/world/europe/british-investigators-say-a-spy-and-his-daughter-were-poisoned-with-a-nerve-agent/2018/03/07/7be45b42-2232-11e8-946c-9420060cb7bd_story.html?utm_term=.beb5c7453e57
5. Paddock, R., Sang-Hun, C., & Wade, N. (2017, February 24). Kim Jong-nam's death, North Korea lets loose a weapon of mass destruction. *The New York Times*. Retrieved from <https://www.nytimes.com/2017/02/24/world/asia/north-korea-kim-jong-nam-vx-nerve-agent.html>
6. Tucker, J. B. (Ed.). (2012). *Innovation, dual use, and security: Managing the risks of emerging biological and chemical technologies*. Cambridge, MA: MIT Press.
7. DiEuliis, D., & Giordano, J. (2017). Gene editing using CRISPR/Cas9: Implications for dual-use and biosecurity. *Protein & Cell*, 9(3), 239-240. doi: 10.1007/s13238-017-0493-4
8. Nguyen, T. H., (2005). Microchallenges of chemical weapons proliferation. *Science*, 309(5737), 1021. doi:10.1126/science.1112445
9. U.S. Federal Bureau of Investigation. (2008, August 18). Science Briefing on the Anthrax Investigation. Press briefing. Retrieved from <https://archives.fbi.gov/archives/about-us/history/famous-cases/anthrax-amerithrax/science-briefing>
10. U.S. Department of Homeland Security. (2015). *Chemical sector-specific plan: An annex to the NIPP 2013* (Rep.). Retrieved from <https://www.dhs.gov/sites/default/files/publications/nipp-ssp-chemical-2015-508.pdf>
11. Broad Institute. (n.d.). Questions and answers about CRISPR. Retrieved from <https://www.broadinstitute.org/what-broad/areas-focus/project-spotlight/questions-and-answers-about-crispr>
12. ThermoFisher Scientific. (n.d.). CRISPR-Cas9. Retrieved from <https://www.thermofisher.com/us/en/home/life-science/genome-editing/genome-editing-learning-center/crispr-cas9-technology-information.html>

13. Organisation for the Prohibition of Chemical Weapons. (1997). *Convention on the Prohibition of the Development, Production, Stockpiling and Use of Chemical Weapons and on Their Destruction, Annex on Chemicals, Guidelines for Schedules of Chemicals*. Retrieved from <https://www.opcw.org/chemical-weapons-convention/download-the-cwc/>
14. Fergusson, I. F. (2009, July 15). *The Export Administration Act: Evolution, provisions, and debate* (CRS Report for Congress). Retrieved from <https://fas.org/sgp/crs/secretary/RL31832.pdf>
15. Sandia National Laboratories. (2014). *Laboratory biosafety and biosecurity risk assessment technical guidance document* (Sandia Rep. No. SAND2014-15939R). Retrieved from <http://prod.sandia.gov/techlib/access-control.cgi/2014/1415939r.pdf>
16. Perkel, J. M., (2015). *Lab-inventory management: Time to take stock*. *Nature*, 524(7563), 125-126. doi:10.1038/524125a
17. National Research Council. (2011). *Prudent practices in the laboratory: Handling and management of chemical hazards, Updated version*. Washington, DC: The National Academies Press. doi: 10.17226/12654
18. Helfrich, J. P. (2010, June 1). The path to the paperless laboratory: A workstation-based consumables inventory management system. Retrieved from <https://www.americanlaboratory.com/914-Application-Notes/490-The-Path-to-the-Paperless-Laboratory-A-Workstation-Based-Consumables-Inventory-Management-System/>
19. Office of Inspector General, Department of Defense. (2017, June 7). *The Army needs to improve controls over chemical surety materials* (DODIG-2017-090). Retrieved from <http://www.dodig.mil/reports.html/Article/1212368/the-army-needs-to-improve-controls-over-chemical-surety-materials/>
20. Fine, C., & P. Peng. *New Opportunities in Physical Access Control Technology* [White paper]. UniKey Technologies, Inc. Retrieved from <https://static1.squarespace.com/static/577e899bb8a79b350ef30353/t/5936bd5ce3df28ebd0be405d/1496759645697/NewOpportunitiesPACS.pdf>
21. U.S. Department of Homeland Security. (2018). *Chemical Facility Anti-Terrorism Standards (CFATS)*. Retrieved from <https://www.dhs.gov/chemical-facility-anti-terrorism-standards>
22. Swedberg, C. (2013, July 22). RFID tracks chemical inventory at Oak Ridge National Laboratory. *RFID Journal*. Retrieved from <http://www.rfidjournal.com/articles/view?10850>
23. Avon Protection. (n.d.). ST53™. Retrieved from <https://www.avon-protection.com/products/st53.htm>
24. Orr, K., & B. Lee. (2009). Demystifying Department of Commerce export controls for the biosafety professional. *Applied Biosafety: Journal of the American Biological Safety Association*, 14(2), 70-71. doi: 10.1177/153567600901400204
25. Government Accountability Office (2011, January 7). *Overview of Department of Defense's (DoD's) Comprehensive Inventory Management Plan*. Washington, D.C. Retrieved from <https://www.gao.gov/products/GAO-11-240R>

26. U.S. Department of Defense. (2010, October). Comprehensive Inventory Management Improvement Plan. Assistant Secretary of Defense for Logistics and Material Readiness. Retrieved from https://www.acq.osd.mil/log/sci/.inventory_mgmt.html/Comp_Invent_Mgmt_Improv_Plans/DoD_CIMIP_Oct2010.pdf
27. The United Nations Office at Geneva. (n.d.). The Biological Weapons Convention. Retrieved from [https://www.unog.ch/80256EE600585943/\(httpPages\)/04FBBDD6315AC720C1257180004B1B2F?OpenDocument](https://www.unog.ch/80256EE600585943/(httpPages)/04FBBDD6315AC720C1257180004B1B2F?OpenDocument)
28. Xiang, M., & Nicholas, Z. (2009). An efficient Bayesian inference approach to inverse problems based on an adaptive sparse grid collocation method. *Inverse Problems*, 25(3), 35013-27. doi:10.1088/0266-5611/25/3/035013
29. National Center for Biotechnology Information, *Triethyl Phosphite*, in *PubChem Compound Database*.
30. The Australia Group. (n.d.). The Australia Group: An introduction. Retrieved from <http://www.australiagroup.net/en/introduction.html>
31. National Research Council. (2014). *The Global Movement and Tracking of Chemical Manufacturing Equipment: A Workshop Summary*. Washington, DC: The National Academies Press. doi:10.17226/18820
32. U.S. Department of Homeland Security. (2018). Ammonium Nitrate Security Program (ANSP). Retrieved from <https://www.dhs.gov/ammonium-nitrate-security-program>
33. National Academies of Sciences, Engineering, and Medicine. (2018). *Reducing the Threat of Improvised Explosive Device Attacks by Restricting Access to Explosive Precursor Chemicals*. Washington, DC: The National Academies Press. doi:10.17226/24862
34. Kotlik, L., Friese, J., & Dudek, G. (2017, September 6). The supply chain difference in chemicals. Retrieved from <https://www.bcg.com/publications/2017/management-supply-chain-difference-chemicals.aspx>
35. Public Law 107–295, Maritime Transportation Security Act of 2002. (2002). Retrieved from <https://www.congress.gov/107/plaws/publ295/PLAW-107publ295.pdf>
36. U.S. Department of Commerce, Bureau of Industry and Security. (n.d.). Overview of Department of Commerce Export Controls for Chemical and Biological Items. Retrieved from <https://www.bis.doc.gov/index.php/forms-documents/product-guidance/868-overview-of-export-licensing-cb-items-pdf/file>
37. Bauer, T. L., Colbaugh, R., Glass, K., & Schnizlein, D. (2013). Use of transfer entropy to infer relationships from behavior. Paper presented at the 8th Annual Cyber Security and Information Intelligence Research Workshop, Oak Ridge, TN.
38. Chandola, V., Banerjee, A., & Kumar, V. (2009). Anomaly detection: A survey. *ACM Computing Surveys*, 41(3), 1-58. doi:10.1145/1541880.1541882
39. Wang, G., Gunasekaran, A., Ngai, E. W., & Papadopoulos, T. (2016). Big data analytics in logistics and supply chain management: Certain investigations for research and applications. *International Journal of Production Economics*, 176, 98-110. doi:10.1016/j.ijpe.2016.03.014

40. Waller, M. A., & Fawcett, S. E. (2013). Data science, predictive analytics, and big data: A revolution that will transform supply chain design and management. *Journal of Business Logistics*, 34(2), 77-84. doi: 10.1111/jbl.12010
41. Camossi, E., Dimitrova, T., & Tsois, A. (2012). Detecting anomalous maritime container itineraries for anti-fraud and supply chain security. *2012 European Intelligence and Security Informatics Conference*. doi:10.1109/eisic.2012.39
42. U.S. Department of Commerce, Bureau of Industry and Security. (2004). *Chemical Weapons Convention: Export and import requirements*. Chemical Weapons Convention Bulletin. Retrieved from http://www.cwc.gov/outreach_industry_publications_cwc007.html
43. Aspen Strategy Group. (2005). Proliferation of biological weapons into terrorist hands. In *The Challenge of Proliferation: A Report of the Aspen Strategy Group*. Washington, DC: Aspen Institute.
44. Quillen, C. (2016). The Islamic State's evolving chemical arsenal. *Studies in Conflict & Terrorism*, 39(11), 1019-1030. doi:10.1080/1057610X.2016.1154364
45. Coker, M., & Kesling, B. (2016, April 1). Islamic State hijacks Mosul University chemistry lab for making bombs. *The Wall Street Journal*. Retrieved from <https://www.wsj.com/articles/islamic-state-hijacks-mosul-university-chemistry-lab-for-making-bombs-1459503003>
46. Organisation for the Prohibition of Chemical Weapons. (2016). *Needs and Best Practices on Chemical Safety and Security Management* (Rep.). Retrieved from https://www.opcw.org/fileadmin/OPCW/ICA/ICB/OPCW_Report_on_Needs_and_Best_Practices_on_Chemical_Safety_and_Security_ManagementV3-2_1.2.pdf
47. Bakanidze, L., Imnadze, P., & Perkins, D. (2010). Biosafety and biosecurity as essential pillars of international health security and cross-cutting elements of biological nonproliferation. *BMC Public Health*, 10(Suppl 1). doi:10.1186/1471-2458-10-s1-s12
48. Crail, P. (2006). Implementing UN Security Council Resolution 1540. *The Nonproliferation Review*, 3(2), 355-399. doi:10.1080/10736700601012193
49. United Nations, 1540 Committee (n.d.). 1540 Matrices. Retrieved from <http://www.un.org/en/sc/1540/national-implementation/1540-matrices.shtml>
50. Organisation for the Prohibition of Chemical Weapons. (n.d.). International transfer of scheduled chemicals. Retrieved from <https://www.opcw.org/our-work/non-proliferation/international-transfer-of-scheduled-chemicals/>
51. U.S. Environmental Protection Agency. (n.d.). Risk Management Plan (RMP) Rule overview. Retrieved from <https://www.epa.gov/rmp/risk-management-plan-rmp-rule-overview>
52. U.S. Department of Justice, Drug Enforcement Administration, Diversion Control Division. (n.d.). Chemical Control Program. Retrieved from https://www.deadiversion.usdoj.gov/chem_prog/index.html

5

Forensic Considerations in the Investigation of Biological Weapons Use

Jamie Glover, HDIAC

Introduction

The field of bioforensics combines the scientific study of biological organisms and processes with the investigatory approach of establishing incident-related facts. Bioforensics, sometimes termed *microbial forensics*, “characterizes, analyzes, and interprets microbial evidence for attribution purposes [1].” Types of microbial evidence include the classification of the biological agent in question, as well as its nucleic acids, protein signatures, additives, and any other detail that may provide insight into the threat posed by an agent, its biological provenance, and, ideally, those responsible for its production and/or release.

Forensic investigations are typically, but not always, directed toward legal or juridical ends. In a national security or homeland defense context, the use of bioforensic capabilities allows government and military investigators to provide evidentiary analyses that provide information regarding “how, when, and where microorganisms were grown and potential methods for dissemination [1].” This information, both in isolation as well as when indexed against other analyses or government intelligence operations, may assist leaders in making an affirmative attribution of blame [1]. At minimum, such information can at least aid in ruling out candidates from a list of potential culpable actors.

The U.S. may seek to deploy its civilian or military bioforensics capabilities in any number of scenarios, such as a suspected biological weapons attack on U.S. soil or the soil of U.S. allies. An accidental release of a bioweapons agent—or substantively equivalent non-dual-use agent—is also a distinct possibility. In such a scenario, the absence of an identifiable perpetrator in no way diminishes the importance of bioforensically establishing an evidentiary chain and determining provenance. When any release occurs, whether intentional or unintentional, bioforensic tools will aid leaders from civilian agencies and DoD to understand the pathogen, learn the circumstances of its release, prepare for its consequences, and protect against future similar occurrences.

Classification Using Multimodal and Phenotypic Data

Bioforensic incident response and investigation efforts in the U.S. include professionals from a wide array of backgrounds and home organizations, including the Centers for Disease Control and Prevention (CDC), DHS, and FBI. The FBI is the lead agency in performing criminal bioforensics investigations. DHS coordinates federal response to a bioweapons attack, and the CDC provides a public health response to mitigate the health effects of an attack [1]. The CDC is also charged with maintaining and superintending the Laboratory Response Network for Biological Threats (LRN-B). This interagency network is responsible for the “specialized characterization of organisms, bioforensics, [and] select agent

activity,” as well as “handling highly infectious biological agents [2].” The network consists of three categories of laboratory types; DoD facilities make up a substantial part of the LRN-B. Additional details are presented in Figure 1.

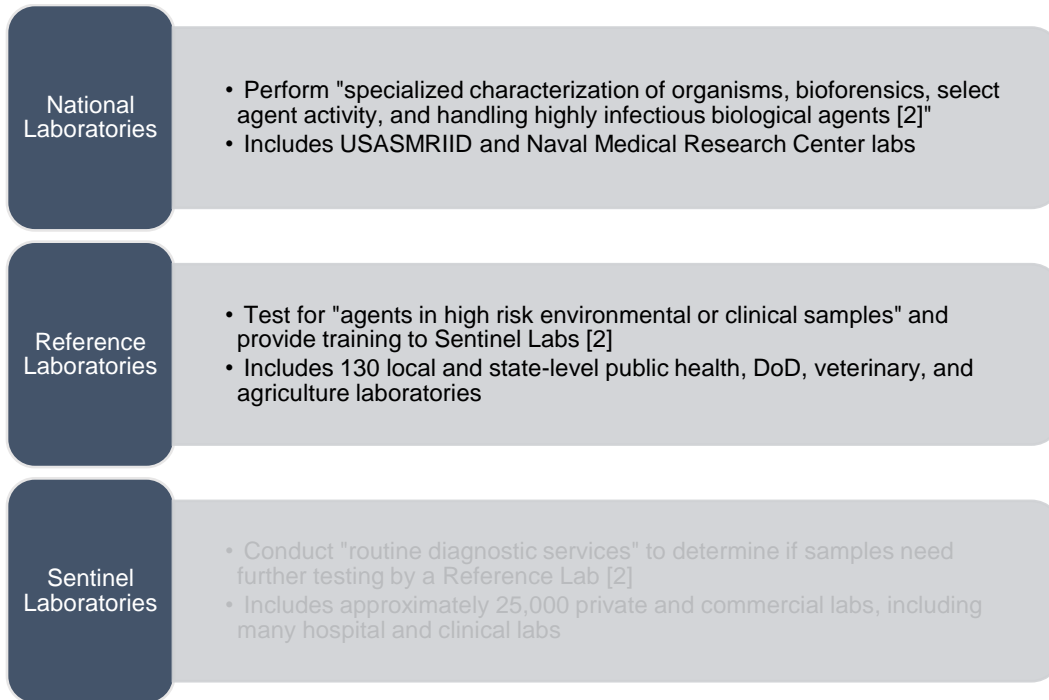

Figure 1. Laboratory categories for the Laboratory Response Network for Biological Threats. Data from [2].

The CDC also conducts U.S. public health surveillance operations—the “collection, analysis, use, and sharing of [public health] data [3]” (e.g., medical diagnostic statistics). Such public health monitoring operations include the practice of syndromatic surveillance—tracking the incidents of symptoms that may be reported prior to the granting of a formal diagnosis. DoD recognizes syndromatic surveillance as a critical tool in achieving early detection of a biological weapon(s) attack [4]. In addition to aiding early detection efforts, public health surveillance also contributes to countermeasure evaluation, ensures responder situational awareness, and helps to elucidate the motivation(s) of the perpetrators behind a biological attack [4].

Several DoD organizations also participate in national bioforensics activities, including biological agent/weapon science, analysis, and intelligence collection, pursued in the interest of optimizing overall biothreat awareness [5]. USAMRIID, for instance, runs the Army’s Special Pathogens Laboratory, which is designated as a National Laboratory within the LRN-B framework [6]. USAMRIID liaises with the World Health Organization in the investigation of emerging disease threats and collaborates with DHS in advancing medical countermeasure efforts [7]. Additional DoD bioforensics activities include, but are not limited to, CBDP [8], RDECOM C&B Center, DTRA, and USACEHR.

Emerging Biothreats

Historically, bioforensics has concerned itself with naturally occurring pathogens—bacteria, viruses, and toxins—which can result in disease and/or death. Advances in biotechnology achieved since the 1970s have, for at least a decade now, empowered researchers and biological engineers with the ability to create new, natural and synthetic engineered viruses and bacteria [9]. Recombinant DNA, gene editing, synthetic biology, and do-it-yourself (DIY) biology have advanced to present the field of bioforensics with a new suite of diagnostic and investigatory challenges.

Gene Editing

The practice of gene editing, or, more properly, *genetic engineering*, has been under development since at least 1972, when Ananda M. Chakrabarty secured the first patent on a bioengineered organism: a strain of *Pseudomonas* altered to metabolize crude oil. Genetically engineered microorganisms are being used in human clinical trials to treat cancer and repair damage caused by heart disease [10]. More recently, the scope of change available to genetic engineers has been greatly expanded by the novel use of the naturally occurring restriction enzyme mechanism known as CRISPR/Cas9 (clustered, regularly interspaced, short palindromic repeats/CRISPR-associated protein-9 nuclease). The technique of gene editing with restriction enzymes is illustrated in Figure 2 [1].

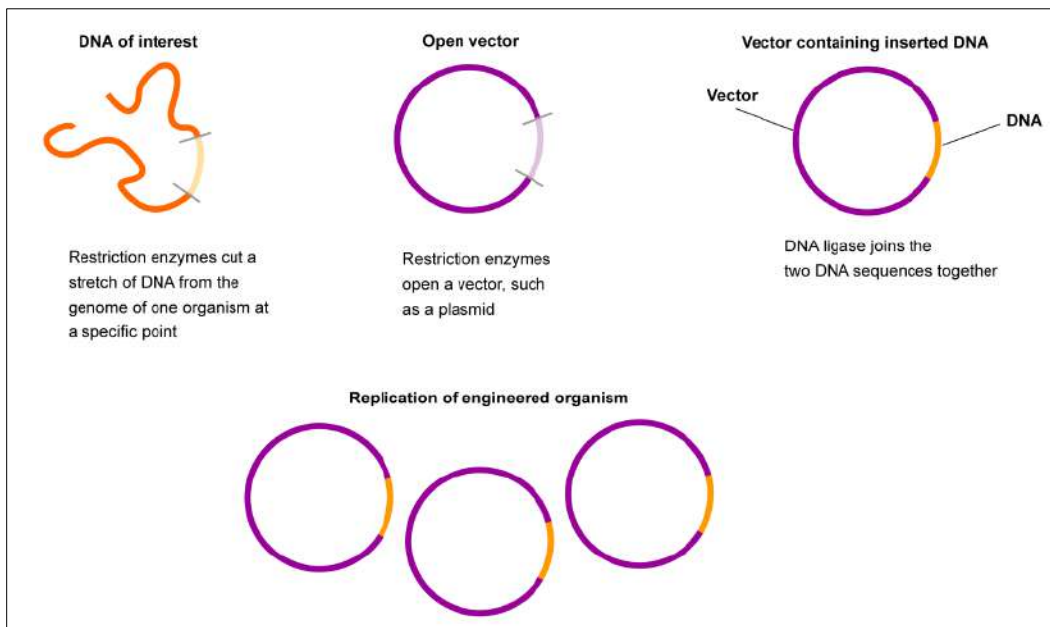

Figure 2. Genetic engineering with restriction enzymes [1]

Though the use of gene editing is focused on well-intentioned endeavors, this technology has security implications stemming from its classification as a dual-use research of concern; in other words, gene editing is just as capable of being used for nefarious purposes, such as developing new biological weapons [11]. Unfortunately for the field of bioforensics, restriction enzyme-based gene editing is more challenging to detect than past gene editing techniques [1].

Synthetic Biology

Synthetic biology couples engineering and computer science tools with those of genetics and molecular biology to result in “synthetic” biological systems [12]. This realm of biotechnology is likely to benefit the DoD as well as civilian populations, as it promises to deliver substantial innovations in sensing, medicine, and human performance enhancement [13]. For example, synthetic biology technologies have been successfully used to complete both *in vitro* and *in vivo* diagnostics, as illustrated in Figures 3 and 4 [14].

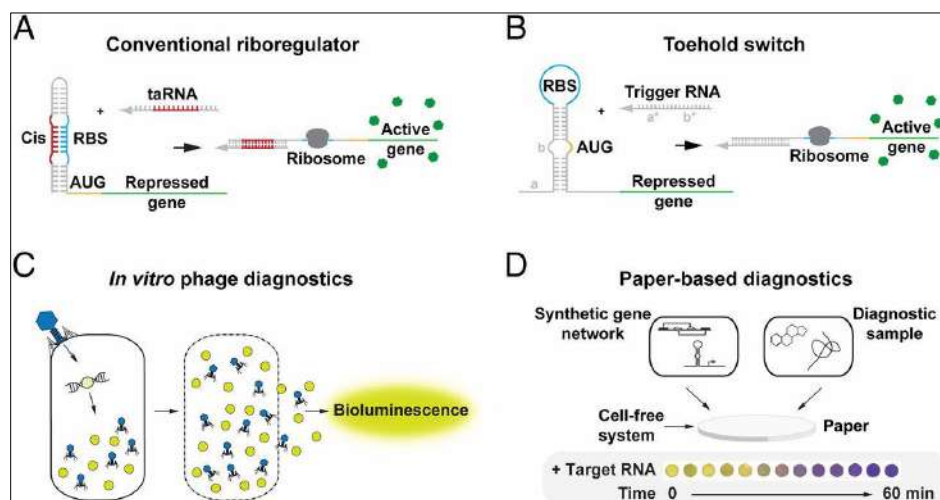

Figure 3. RNA-based biosensors and synthetic biology platforms for *in vitro* diagnostics. (A) Conventional riboregulators inhibit the translation of mRNA from the start codon (AUG) by sequestering the RBS through a cis-repression sequence (Cis), which is relieved in the presence of the transactivator RNA (taRNA). (B) In the toehold switch model, the RBS is located in a hairpin loop within the repressed RNA's 5' untranslated region and a toehold is added to the 5' end. This alternative regulatory RNA structure allows for a much larger RNA sequence space to be detected. (C) *In vitro* phage-based diagnostics rely on specific recognition of target bacterial species by engineered phage particles. Once the phage has bound, the engineered phage genome is injected into the targeted cells, where the reporter gene is expressed (i.e., luciferase; yellow circles) and phage replicate. (D) Paper-based systems are assembled by freeze-drying a diagnostic gene network and a cell-free coupled transcription/translation system into paper or other porous materials. The gene circuit becomes active when rehydrated with the test sample, containing target RNAs or small molecules [14].

With seemingly infinite areas of application, synthetic biology techniques and approaches are also regarded as dual-use researches of concern [12]. Assessments performed by DoD and the U.S. Government Accountability Office (GAO) on synthetic biology's technical status and likely future development raise concerns that its associated technologies may hasten the production of novel, never-before-in-existence biological agents that display more virulent characteristics, and/or wholly new biological features—both of which pose heightened threats to U.S. national security and the warfighter [1, 13].

Do-It-Yourself Biologists

The potential for the intentional or unintentional creation of new bioweapons agents may also increase as a result of the rise of DIY biology. Some organizations have been training anyone—from graduate students to the general public—who is interested in merely playing with biology. One example is DIYbio, which began in

2008 to pursue its “mission of establishing a vibrant, productive[,] and safe community of DIY biologists,” to foster international collaboration among amateur biologists [12, 15]. While promoting involvement in life sciences may be beneficial to the accretion of scientific knowledge, legitimate and enduring concerns exist regarding the risks of amateurs, armed with quite advanced biotechnology tools and information, either intentionally or inadvertently developing harmful pathogens. In recognition of the potential threat posed by DIY biologists, the FBI’s Bioterrorism Prevention Team has been engaged in heavy outreach efforts for many years, seeking to prevent the work of amateur biologists from becoming biothreats [12, 16].

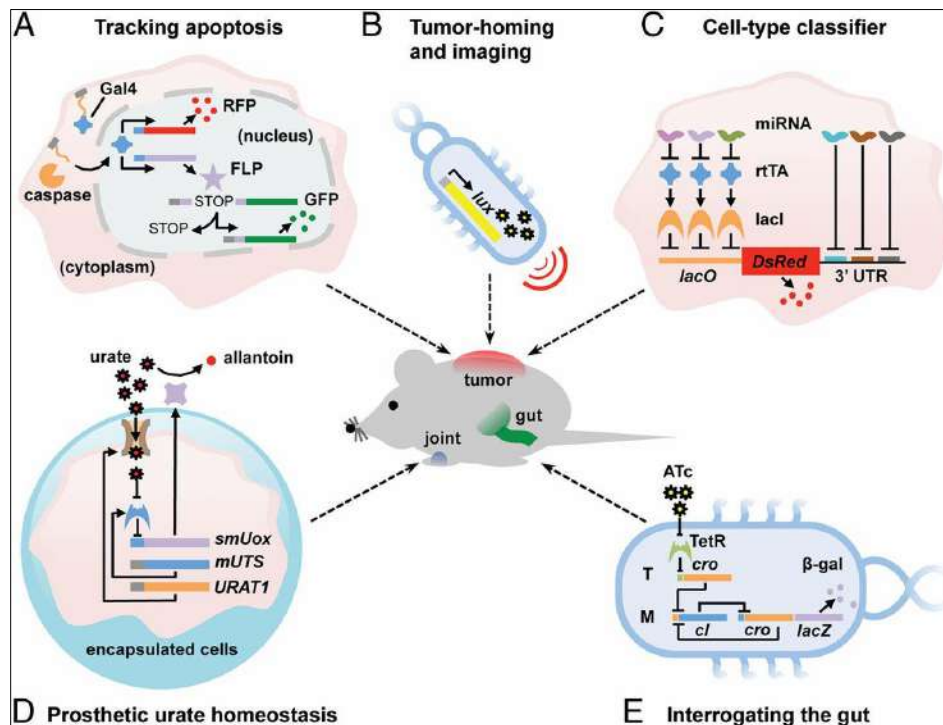

Figure 4. Synthetic biology devices for in vivo diagnostics. (A) *The CaspaseTracker*: Cytoplasmic Gal4 (blue) is released to the nucleus by apoptotic caspases (orange), where it activates RFP and FLP recombinase (violet star) expression, leading to persistent GFP expression and enabling apoptosis/anastasis tracking (demonstrated in fruit flies). (B) Engineered bacteria naturally home in on tumors and express their synthetic circuits, producing bioluminescence for in situ tumor imaging. (C) The cell-type “classifier” compares endogenous expression levels of three “high” miRNAs (left) and three “low” miRNAs (right) to a preset HeLa profile. If all of the high miRNAs are above the threshold, this profile leads to RNAi silencing of the transactivator (rtTA; blue) of the output gene’s repressor (LacI; orange), allowing for output expression (DsRed; red dots). If all of the low miRNAs are below the threshold, the output mRNA is not degraded via RNAi (demonstrated in cell culture). (D) High urate levels lead to tumor lysis syndrome and gout. A prosthetic urate homeostasis system transports urate (red cogs) into the encapsulated cells via constitutive URAT1 (orange) expression, where it releases mUTS’s (blue) repression of smUox (violet), a secreted uricase that converts the urate to renally secretable allantoin (red dots). (E) Bacteria engineered to record mammalian gut microbiome exposure events. The memory element (M), comprised of a bacteriophage lambda *cl/cro* (blue/orange) switch and containing a *lacZ* reporter (violet), is toggled to the “on” (*cro*, *lacZ*) state when the Trigger element (T) detects ATc (black cogs) and TetR (green) repression of a second *cro* copy is released. The detection of ATc results in the expression of β -gal from the *lacZ* gene, which is readily measured in fecal samples [14].

Developments in Forensics

In 2017, the GAO convened an international group of bioforensics experts to identify “capability needs” in the field. The GAO outlined 14 areas in which bioforensic technologies were found wanting, and their innovation necessary to advance the field. Table 1 lists these “capability needs,” arranged by area of bioforensics practice [1].

Area	Capability need
Science	<ol style="list-style-type: none"> 1. Identify, monitor, and characterize agreed on microbial species of most concern, including phenomena such as population dynamics and environmental effects to gene stability, gene transfer, and mutation rates 2. Continue research to determine mechanisms of pathogenicity, including virulence factors and host immune responses, focusing on problems related to bioforensics 3. Develop methods to distinguish natural, accidental, and deliberate outbreaks of infectious diseases, including those involving an engineered organism, rapidly and with high confidence 4. Identify forensic signatures and improved characterizations for known, emerging, enhanced, genetically engineered, and synthetically derived agents 5. Develop sensitive and broad detection capabilities for known, emerging, enhanced, genetically engineered, and synthetically derived agents 6. Continue research to realize the promise of metagenomics as it applies to microbial forensics and develop other technologies that can be applied to microbial forensics, including proteomics, metabolomics, transcriptomics, glycomics, immunogenomics, and lipidomics that can provide advantages over traditional methods
Technology and methods	<ol style="list-style-type: none"> 1. Adapt physical science applications to microbial forensics 2. Adapt more advanced, faster, and cheaper assay and sequencing technologies and standardize and validate them for bioforensics 3. Compile all existing protocols in use (e.g., collection, preservation, recovery, concentration, sampling, extraction and isolation, preservation, sequencing) to determine whether and how they have been validated and identify current research gaps and research efforts to avoid duplication 4. Develop and validate processes and analytical methods for microbial forensics (e.g., sample collection, preservation, recovery, handling, storage, packaging, and transportation), including establishing standards (e.g., for components, processes, materials, data, performance), to demonstrate the information generated can answer key investigative and legal questions 5. Develop and validate nongenetic orthogonal methods to conduct sample characterization
Bioinformatics and data	<ol style="list-style-type: none"> 1. Create data repositories and reference collections for pathogens and other microorganisms and develop standards for metadata 2. Create reference collections for standards and other reference materials required for the development and validation of microbial forensics methods 3. Develop and refine bioinformatics and statistical methods for evaluating evidence in microbial forensics capable of incorporating diverse analytical results into forensics comparisons and building networks and models to help investigators draw inferences regarding sample relatedness with described confidence intervals. This should include new algorithms that scale to very large or complex databases

Table 1. Capability needs for bioforensics identified by experts [1]

Because of these findings, the GAO recommended that DHS and the FBI perform “a formal bioforensics capability gap analysis” in order to “identify scientific and technical gaps and needs in bioforensics capabilities to help guide current and future bioforensics investments [1].” The GAO also recommended that the DHS-FBI effort be updated periodically to remain current and useful. At the time of writing, action on this recommendation remains outstanding [17].

Bioforensic Science and Technology

The practice of bioforensics relies on expertise drawn from a range of disciplines and technical sub-fields, including those that focus on bacterial, viral, toxic, or genomic data, respectively. Table 2 presents a summary of agent- and methods-based capabilities used in bioforensic analysis, and details the discrete analytical or methodological types therein (e.g., the use of “real-time PCR” is a component of the molecular biology capability) [1].

CAPABILITY	TYPE OF ANALYSIS
Analytical chemistry	<i>Identification, characterization of ricin, abrin, and other protein toxins (toxinology) using mass spectrometry, which also supports proteomics analyses</i>
Bacteriology	<i>Culture identification, phenotypic characterization of multiple organisms</i>
Genomics	<i>Whole genome genotyping, large-scale comparative analyses, incremental metagenomics capability, inferential analysis</i>
Toxinology	<i>Identification, characterization of ricin, abrin, and other protein toxins (toxinology) using mass spectrometry, which also supports proteomics analyses</i>
Virology	<i>Culture identification, phenotypic characterization of viruses</i>

Table 2. Agent-Based and Methods-Based Capabilities for Bioforensics Analyses. Adapted from [1].

Metagenomics and proteomics are two seminal classes of technology that have significantly—or revolutionarily, in the minds of many—enhanced the scope and accuracy of the practice of bioforensics. In summary, metagenomics allows for more comprehensive bioforensics analysis. It examines the metagenome, which consists of “the collective genome of microorganisms from [a given] environmental sample [18].” This means that samples analyzed with the tools and approaches of metagenomics could “contain both microbial and human DNA as well as mixtures that derive from possible processing steps (growth media, etc.), which could provide links to a possible source [1].” Figure 5 depicts the extreme variety of organism types present in a single environmental sample analyzed via metagenomics analysis. Such samples are likely to include both prokaryotic and eukaryotic organisms, and such analysis is likely to yield broad-brush scientific conclusions about biological composition overall (percentage of genetic material versus simple protein or nucleic acid molecules), or discrete bioforensic evidentiary conclusions.

Recent DHS-led research and development efforts have emphasized the pursuit of advances in whole-genome sequencing via metagenomics, seeking to advance the ease and facility with which wide-area analyses of complex samples can be conducted with high confidence [1].

Proteomics is used to identify the array of proteins present in the array of multiple organisms and organism types present in a given sample [19]. Identifying the proteins expressed by an organism’s genetic coding can lead to the identification of the organism’s sources of sustenance; this in turn can identify the growth medium and other environmental factors in which an organism was cultured and grown to production. This could ultimately provide essential details about the machinery and individuals responsible for weaponizing a biological organism. Because of this evidentiary benefit of proteomics, experts have suggested that its use may “rival [the analysis of] genetic information [alone] when methods have matured [1].”

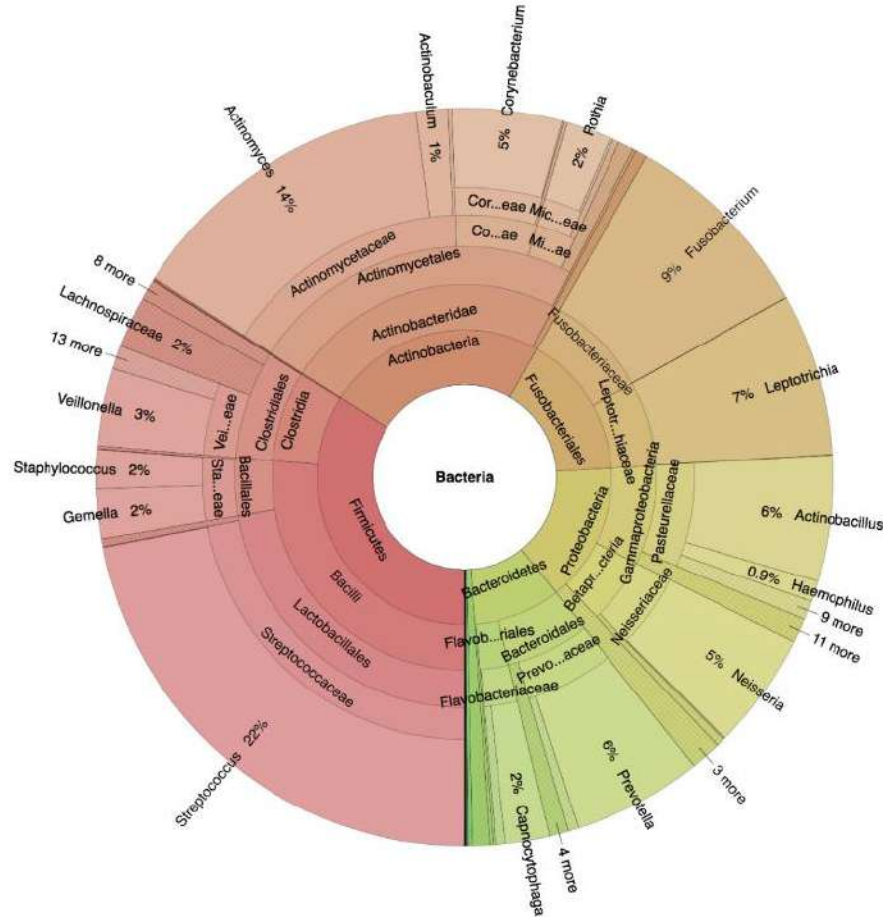

Figure 5. The Possible Composition of a Metagenomics Sample [1]

The DHS Bioforensics Roadmap identifies gaps and capabilities and suggests timelines for specific technologies and R&D programs. The first Bioforensics Roadmap was issued in 2014 and spanned six years. For the short-term, DHS is focused on developing bioforensics capabilities that meet the needs of current FBI cases. For its longer-term efforts, DHS is undertaking initiatives to improve its “genomics and proteomics capabilities,” which are expected to “provide a complementary capability that will link proteomic analysis to metagenomics analysis of complex samples, thereby providing additional information about an agent [1].” The roadmap is shown in Figure 6.

Bioforensics and Data

Bioinformatics applies the tools of mathematical, statistical, and computer sciences to organize and analyze massive quantities of biological data [20]. Numerous organizations are advancing the frontier of bioinformatics by expanding biological data collection, storage, and analysis capabilities and practices. This is essential to bioforensics analysis. As new methods and strategies continue to generate more data, and at an accelerating rate, future metagenomics analyses will, for example, require the analysis of very large datasets that require advanced computational power and statistical capabilities to be completed [1].

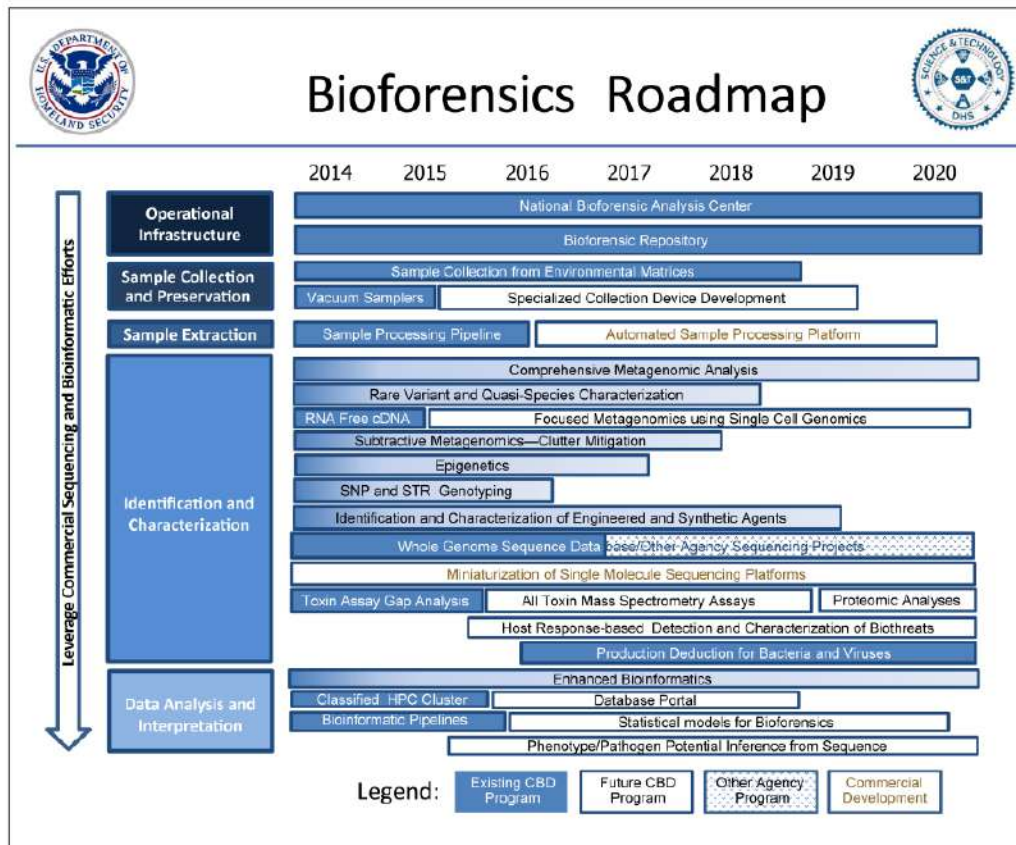

Figure 6. DHS 2014 Bioforensics Roadmap [1]

DTRA has managed Los Alamos National Laboratory development of a tool known as EDGE, which is “a highly adaptable bioinformatics platform that allows laboratories to quickly analyze and interpret genomic sequence data [21].” The EDGE system can be used to analyze novel biological threats, as well as clinical and environmental samples. EDGE was designed specifically to bring the conduct of sample analysis closer in proximity to the source of the sample. This design quality was targeted with forward-deployed scenarios and facilities outside the continental U.S. in mind; however, because EDGE reduces the amount of time required to characterize a biological sample, it could be beneficial for use in the field for both CONUS and non-DoD analyses.

DTRA is also applying “cloud-based data fusion, unstructured data discovery, algorithms for ‘deep learning’, and adaptable geospatial visualization tools” to the detection and identification of biological threats [22]. Additional bioinformatics advances involving DoD include those at the Collaborative Health Initiative Research Program’s Bioinformatics Core at the Uniformed Services University [23], the Genomics and Bioinformatics Department in Naval Medical Research and Development at the U.S. Naval Medical Research Center [24], and DoD’s High Performance Computing Modernization Program’s Computational Chemistry, Biology, and Materials Science technology area [25].

The FDA and DOE are also involved in ushering in advances in bioinformatics. FDA’s National Center for Toxicological Research (NCTR) has developed multiple

bioinformatics tools in recent years [26]. NCTR-produced tools include ArrayTrack™, which allows grouping samples by gene expression likeness through two-way hierarchical cluster analysis [27], and pattern recognition for DNA microarray data using its Decision Forest software program [28]. Furthermore, the DOE Genomic Science program is developing new tools allowing “capturing and archiving large and complex datasets,” as well as methods for “analysis, distillation, and integration of systems biology data [29].” DOE laboratories, including Oak Ridge National Laboratory [30] and Pacific Northwest National Laboratory [31], are also developing bioinformatics capabilities.

Though GAO experts identified a continuing need for a reference collection of pathogen data, DHS is developing just that. As of 2017, DHS was in the process of developing an internal reference database of biological materials, known as the National Bioforensics Analysis Center Bioforensic Repository Collection (BRC). The database will serve as long-term storage for “select and nonselect agent bacteria and viruses, toxins, and their near neighbors.” It will provide reference materials used in “comparative forensic analyses, assay development and evaluation, and proficiency testing.” DHS is actively expanding the BRC, adding strains obtained from governmental, academic, commercial, and international sources [1].

Conclusion

National bioforensics capabilities have made great strides since the Amerithrax case in 2001; the years-long forensic investigation could now be completed much more quickly [1]. However, additional advances are needed to ensure the U.S. possesses highly effective and dynamic bioforensics capabilities in the longer term. DoD will continue to be in the forefront of bioforensics technology advancement for the medium-term.

For example, over the next four years, the Defense Advanced Research Projects Agency’s (DARPA) Friend or Foe Program from its Biological Technologies Office will seek to advance biosurveillance by developing “a platform technology that rapidly screens unfamiliar bacteria to establish their pathogenicity and even discover unknown pathogenic traits” by determining its phenotypes. The Friend or Foe program would also log newly-identified bacteria into reference databases, to expand the catalog of information as well as prevent duplicative identification efforts in the future. The DARPA effort will test for three pathogenic traits: (a) survival and establishment in a host, (b) host harm, and (c) resistance to host antibodies and/or antibiotics. DARPA stated successful completion of the technology will be “a powerful deterrent to the development of engineered biothreats [32].”

The information technology expansion of the third industrial revolution has made the acquisition of the knowledge and materials needed to construct a chemical or biological weapon many orders of magnitude easier than it was just a few decades ago. The continued development of advanced capabilities will require scientists and engineers to consider existing, emerging, and future biothreats.

References

1. U.S. Government Accountability Office. (2017, January 11). *Bioforensics: DHS needs to conduct a formal capability gap analysis to better identify and address gaps* (Rep. No. GAO-17-177). Washington, D.C.: U.S. Government Accountability Office. Retrieved from <https://www.gao.gov/assets/690/682007.pdf>
2. Centers for Disease Control and Prevention. (2018, April 13). Laboratory response network for biological threats (LRN-B). Retrieved from <https://emergency.cdc.gov/lrn/biological.asp>
3. Centers for Disease Control and Prevention. (2017, November 30). Background – surveillance strategy. Retrieved from <https://www.cdc.gov/surveillance/Improving-Surveillance-Background.html>
4. U.S. Army Medical Research Institute of Infectious Diseases. (2014). *USAMRIID's Medical Management of Biological Casualties Handbook* (8th ed.). Fort Detrick, MD: United States Department of Defense, U.S. Army Medical Department, U.S. Army Medical Research Institute for Infectious Disease. Retrieved from <http://www.usamriid.army.mil/education/bluebookpdf/USAMRIID%20BlueBook%208th%20Edition%20-%20Sep%202014.pdf>
5. U.S. Government Accountability Office. (2017, October 11). *Biodefense: Federal efforts to develop biological threat awareness* (Rep. No. GAO-18-155). Washington, D.C.: U.S. Government Accountability Office. Retrieved from <https://www.gao.gov/products/GAO-18-155>
6. U.S. Army Medical Research Institute of Infectious Diseases. (2016, October 6). Resource for all DOD. Retrieved from <http://www.usamriid.army.mil/SPL/index.cfm>
7. Wheeler, G. A. (2016, December 2). USAMRIID: Biodefense solutions to protect our nation. U.S. Army Medical Research Institute of Infectious Diseases. Retrieved from <http://www.usamriid.army.mil/>
8. Office of the Assistant Secretary of Defense for Nuclear, Chemical, and Biological Defense Programs. (n.d.). Chemical and biological defense. Retrieved from <https://www.acq.osd.mil/ncbdp/cbd/>
9. Almosara, J. O. (2010). *Biotechnology: Genetically engineered pathogens* (The Counterproliferation Papers, Future Warfare Series No. 53, Rep.). Maxwell Air Force Base, AL: Air University. Retrieved from <http://www.dtic.mil/dtic/tr/fulltext/u2/a556597.pdf>
10. Winblad, N., & Lanner, F. (2017, August 2). Biotechnology: At the heart of gene edits in human embryos. *Nature*, *548*, 398-400. Retrieved from <https://www.nature.com/articles/nature23533>
11. DiEuliis, D., & Giordano, J. (2018). Gene editing using CRISPR/Cas9: Implications for dual-use and biosecurity. *Protein & Cell*, *9*(3), 239-240. doi:10.1007/s13238-017-0493-4
12. National Academy of Sciences, Engineering, and Medicine. (2017). *Dual use research of concern in the life sciences: Current issues and controversies*. Washington, D.C.: The National Academies Press. doi:10.17226/24761
13. U.S. Department of Defense Office of Technical Intelligence, Office of the Assistant Secretary of Defense for Research & Engineering.

- (2015, January). Technical assessment: Synthetic biology (Rep.). Washington, D.C.: U.S. Department of Defense. Retrieved from <http://defenseinnovationmarketplace.mil/resources/OTI-SyntheticBiologyTechnicalAssessment.pdf>
14. Slomovic, S., Pardee, K., & Collins, J. J. (2015). Synthetic biology devices for in vitro and in vivo diagnostics. *Proceedings of the National Academy of Sciences*, 112(47), 14429-14435. doi:10.1073/pnas.1508521112
 15. DIYbio. (n.d.) An institution for the do-it-yourself biologist. Retrieved from <https://diybio.org/>
 16. Lempinen, E. W. (2011, April 1). FBI, AAAS collaborate on ambitious outreach to biotech researchers and DIY biologists. American Association for the Advancement of Science. Retrieved from <https://www.aaas.org/news/fbi-aaas-collaborate-ambitious-outreach-biotech-researchers-and-diy-biologists>
 17. U.S. Government Accountability Office. (2017, February 10). Bioforensics: DHS needs to conduct a formal capability gap analysis to better identify and address gaps. Retrieved from <https://www.gao.gov/products/GAO-17-177>
 18. *Nature*. (n.d.). Metagenomics. *Nature*. Retrieved from <https://www.nature.com/subjects/metagenomics>
 19. *Nature*. (n.d.). Proteomics. *Nature*. Retrieved from <https://www.nature.com/subjects/proteomics>
 20. Luscombe, N. M., Greenbaum, D., & Gerstein, M. (2001). What is bioinformatics? A proposed definition and overview of the field. *Methods of Information in Medicine*, 40(4), 346-358. Retrieved from <https://www.ncbi.nlm.nih.gov/pubmed/11552348>
 21. Defense Threat Reduction Agency. (n.d.). *EDGE: Empowering the Development of Genomics Expertise* [Fact Sheet]. Author. Retrieved from <http://www.dtra.mil/Portals/61/Documents/edge-fact-sheet---pa-approved-v2-distro-statement.pdf>
 22. Defense Threat Reduction Agency. (n.d.). Data integration and analysis. Retrieved from <http://www.dtra.mil/Research/Data-Integration-Analysis/>
 23. Uniformed Services University. (n.d.). Bioinformatics. Retrieved from <https://www.afrii.usuhs.mil/chirp/bioinformatics>
 24. Naval Medical Research and Development Enterprise Laboratories. (n.d.). Biological defense research. Retrieved from http://www.med.navy.mil/sites/nmrc/NMRC/NMRC_Offices/Pages/BD RD.aspx
 25. DoD High Performance Computing Modernization Program. (n.d.). Computational chemistry, biology, and materials science (CCM). Retrieved from <https://www.hpc.mil/index.php/technology-areas/computational-chemistry-and-materials-science-ccm>
 26. U.S. Food and Drug Administration. (2018, May 1). Bioinformatics tools. Retrieved from <https://www.fda.gov/ScienceResearch/BioinformaticsTools/default.htm>
 27. U.S. Food and Drug Administration. (2018, March 30). ArrayTrack™ HCA-PCA Standalone Package – powerful data-exploring tools. Retrieved from

- <https://www.fda.gov/ScienceResearch/BioinformaticsTools/ArrayTrack8482HCA-PCASandalonePackage/default.htm>
28. U.S. Food and Drug Administration. (2018, March 30). Decision Forest. Retrieved from <https://www.fda.gov/ScienceResearch/BioinformaticsTools/DecisionForest/default.htm>
 29. U.S. Department of Energy Genomic Science Program. (2018, April 23). Cross-cutting computational biology, bioinformatics, and predictive modeling. Retrieved from <https://genomicscience.energy.gov/compbio/>
 30. Oak Ridge National Laboratory. (n.d.) Computational Biology and Bioinformatics. Retrieved from <https://www.ornl.gov/division/bsd/cbb>
 31. Waters, K. (2018, January). Bioinformatics Resource Manager. Pacific Northwest National Laboratory. Retrieved from <https://www.pnnl.gov/sysbio/research/bsi/bioanalytics/Bioinformatics.stm>
 32. Defense Advanced Research Projects Agency. (2018, February 7). Playing 20 questions with bacteria to distinguish harmless organisms from pathogens. Retrieved from <https://www.darpa.mil/news-events/2018-02-07a>

6

Afterword

*Joel Hewett, HDIAC
Jamie Glover, HDIAC*

Just after dawn on Monday, March 20, 1995, five individuals boarded subway trains in three different cities in Japan, all bound for the Kasumigaseki station in downtown Tokyo. Each carried multiple plastic bags filled with a potent nerve agent in liquid form, puncturing each on the floor by means of a sharpened umbrella tip before detrainning and fleeing the scene. Phone calls to emergency lines soon reported “strange smells” and “powerful odors” within the Kasumigaseki station [1]. In all, the attack would leave 12 dead and many thousands seeking treatment at local hospitals.

The investigation began soon thereafter. The National Police Agency requested two chemical warfare experts be sent from the military, and, approximately three hours after the start of the attack, the agent was identified as sarin. Police and military authorities used chromatograph-mass spectrometry to diagnose the agent [1].

The information technology expansion of the third industrial revolution has made the acquisition of the knowledge and materials needed to construct a chemical or biological weapon many orders of magnitude easier than it was just a few decades ago. Keeping precursor chemicals controlled and protected is a major challenge in unstable nations, or areas marked by insurgent attacks [2]. The proliferation of low-cost “gene synthesis” services and technologies, which rapidly assemble bespoke DNA/RNA strands or other genetic constructs from organic building blocks, has made “do-it-yourself” biological weapons a distinct possibility [3].

Japan’s National Police Agency was able to so quickly identify sarin as the nerve agent in the 1995 subway attacks in part out of luck. Because the terrorist group behind the attack had used sarin in an attack on Matsumoto City nine months earlier, by March 1995 the police had already collaborated with U.S. Army scientists at the Edgewood Chemical Biological Center (now the RDECOM C&B Center) on chemical analysis [4]. By the time of the 1995 attack, authorities were better equipped to identify sarin liquid and gas. Without such thorough preparation after the initial attack, the second could have led to larger loss of life.

The immediacy and severity of the threat posed by improvised or new formulations of chemical and biological weapons is unknown. What is certain, however, is that the United States’ technological capabilities in detecting, tracking, identifying, and investigating chemical and biological weapons use must advance in tandem.

State-of-the-art methods for investigating chemical and biological weapons encompass more than just use of the most advanced sensors and techniques for analyzing environmental samples gathered in the field. As Sandia National Laboratories authors Trisha Miller and Sean DeRosa explain in their chapter,

“methods and tools that track legitimate-use agents, precursors, equipment” and other resources that may function as component parts of a chemical or biological weapon are a “key component” of investigating their use. Maintaining situational awareness of these assets helps government and military officials to prevent, interdict, warn against, and ultimately respond to a chemical or biological attack. When combined with sensor-based detection techniques, supply chain situational awareness provides the most contextual and comprehensive level of insight for investigating chemical/biological weapons use.

References

1. Pangi, R. (2002, February). *Consequence management in the 1995 sarin attacks on the Japanese subway system* (BCSIA Discussion Paper 2002-4, ESDP Discussion Paper ESDP-2002-01). Cambridge, MA: John F. Kennedy School of Government, Harvard University. Retrieved from https://www.belfercenter.org/sites/default/files/legacy/files/consequence_management_in_the_1995_sarin_attacks_on_the_japanese_subway_system.pdf
2. Oppenheimer, A. (2008, November 28). The threat of chemical weapons: Use by non-state actors. Organization for the Prohibition of Chemical Weapons. Retrieved from <https://www.opcw.org/news/article/the-threat-of-chemical-weapons-use-by-non-state-actors/>
3. Jansen, H. J., Breeveld, F. J., Stijnis, C., & Grobusch, M. P. (2014, June). Biological warfare, bioterrorism, and biocrime. *Clinical Microbiology and Infection*, 20(6), 488-496. doi:10.1111/1469-0691.12699
4. Tu, A. T. (2007). Toxicological and chemical aspects of sarin terrorism in Japan in 1994 and 1995. *Toxin Reviews*, 26(3), 231-274. doi:10.1080/15569540701496321

